

# Thermal Control Accessories

# IP-SSVH

VENT HOODS | STAINLESS STEEL | IP55

STANDARD

IP Enclosures provide stainless steel vent hoods to increase protection of fans, vents, vent filters and internal components. The top of vent hoods are inclined to prevent settling and building up to liquids, corrosive solids, minerals, dust, dirt and debris on top of the vent hood. All IP Enclosures vent hoods are manufactured with nutserts for ease of installation and gaskets to prevent crevice corrosion. Vent hoods are designed to be fitted to IP Enclosures electrical enclosures, field cabinets, data racks and are supplied with fasteners.

**Protection:** IP55 (When used with IP Enclosures fans and filters)

**Standard:** IEC/EN 60529, IEC/EN 62208



**Material:**

- Body: 1.5mm grade 316L stainless steel

**Surface Finish:** 0.4 micron Ra surface brushed finish.



*Image is for reference only. Refer to the table below for exact sizes and specifications.*

Part Number	Vent Hood Size	Weight	To Suit Fan	To Suit Vent
SKU	HxWxD (mm)	Kilogram (Kg)	Standard; Outdoor UV	Standard; Outdoor UV
IP-SSVH2517	250H x 170W x 50D	1.0	IP-V1100; IP-V1100-UV	IP-V1000; IP-V1000-UV
IP-SSVH3020	300H x 200W x 50D	1.5	IP-V1100; IP-V1100-UV	IP-V1000; IP-V1000-UV
IP-SSVH3222	320H x 220W x 50D	2.3	IP-V1100 to IP-V2200; IP-V1100-UV to IP-V2200-UV	IP-V1000 to IP-V2000; IP-V1000-UV to IP-V2000-UV
IP-SSVH4030	400H x 300W x 50D	2.5	IP-V1100 to IP-V3200; IP-V1100-UV to IP-V3200-UV	IP-V1000 to IP-V3000; IP-V1000-UV to IP-V3000-UV
IP-SSVH4737	470H x 370W x 75D	6.0	IP-V1100 to IP-V4400; IP-V1100-UV to IP-V4400-UV	IP-V1000 to IP-V4000; IP-V1000-UV to IP-V4000-UV
IP-SSVH5040	500H x 400W x 75D	4.0	IP-V1100 to IP-V5500; IP-V1100-UV to IP-V5500-UV	IP-V1000 to IP-V5000; IP-V1000-UV to IP-V5000-UV

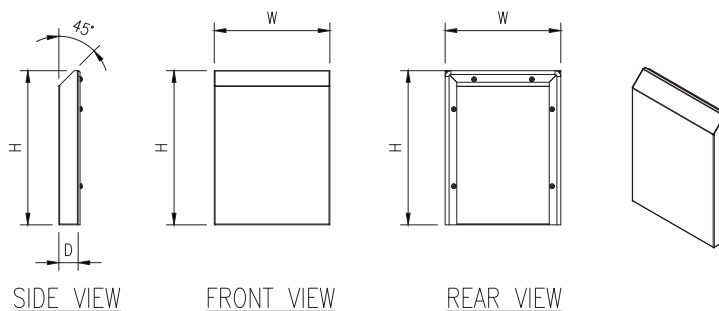

**NOTE:** 2D drawing is for reference only. Refer to CAD files for complete details.

# Thermal Control Accessories

# IP-SSVH

VENT HOODS | STAINLESS STEEL | IP55

STANDARD

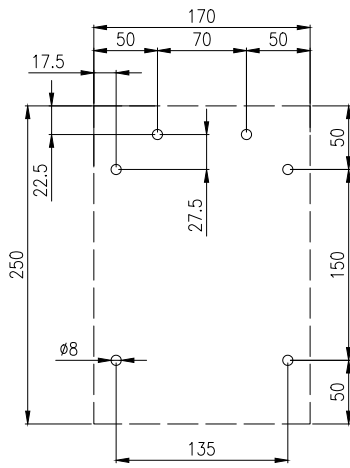

IP-SSVH2517

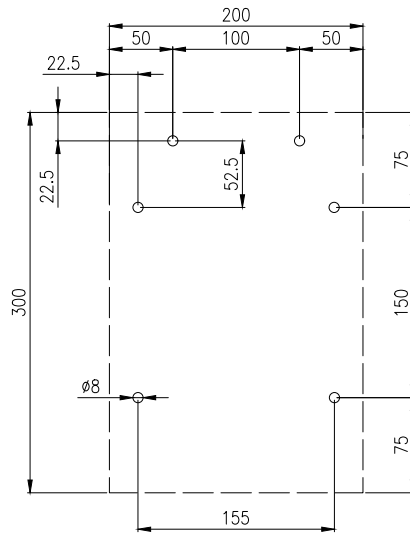

IP-SSVH3020

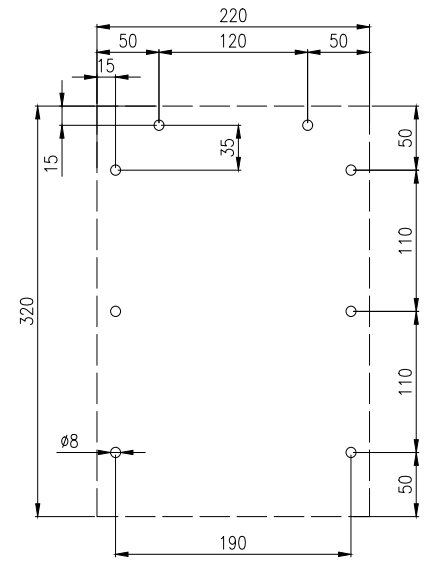

IP-SSVH3222

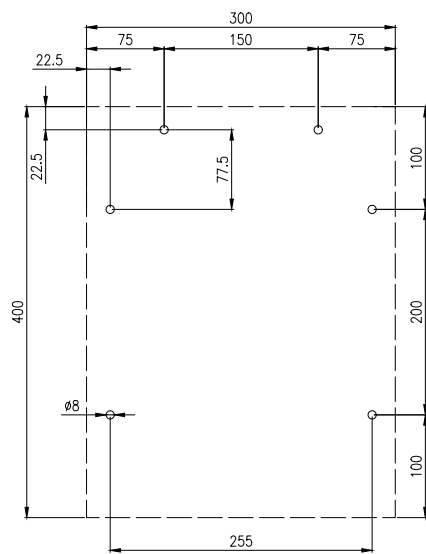

IP-SSVH4030

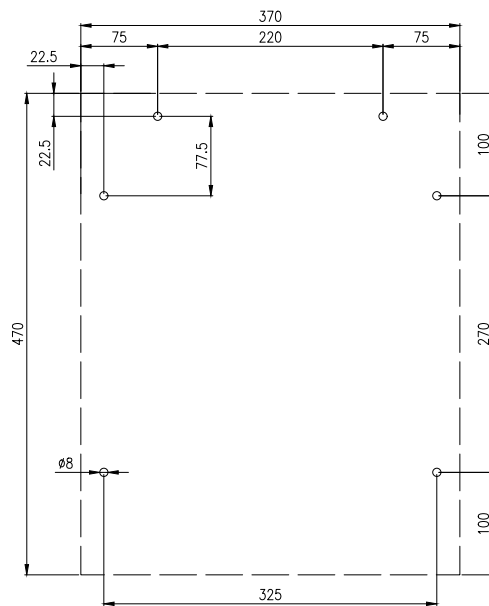

IP-SSVH4737

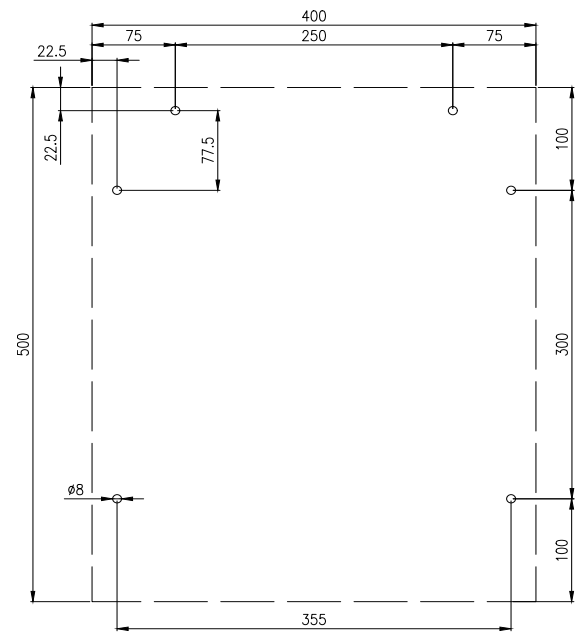

IP-SSVH5040

## MOUNTING HOLE DIAGRAMS

**NOTE:** Drilling templates provided.