

SECTION AV-AV

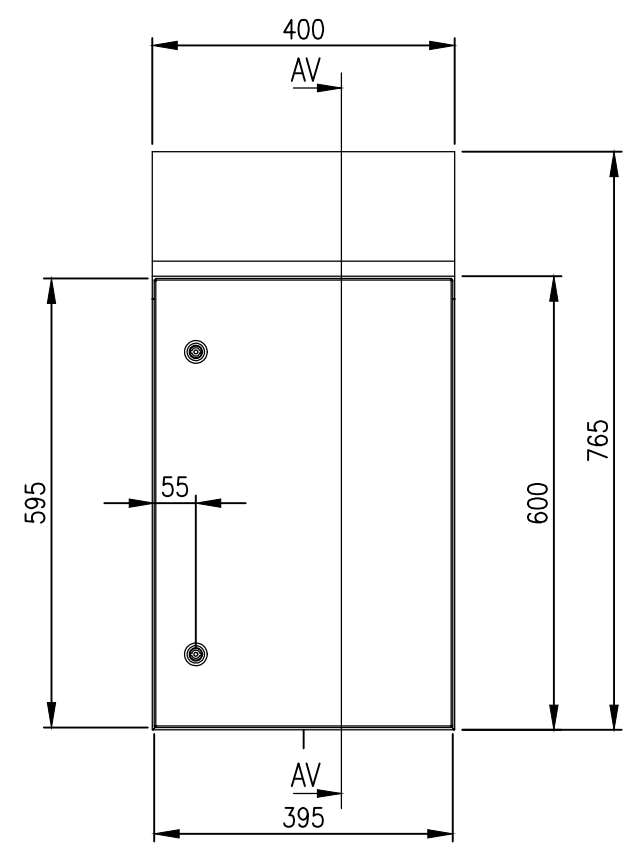

FRONT VIEW

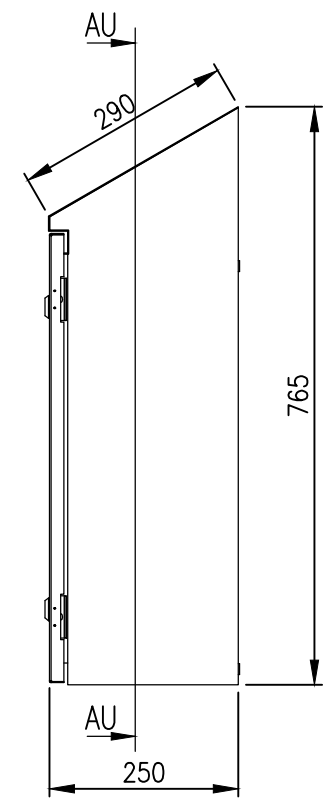

RIGHT SIDE VIEW

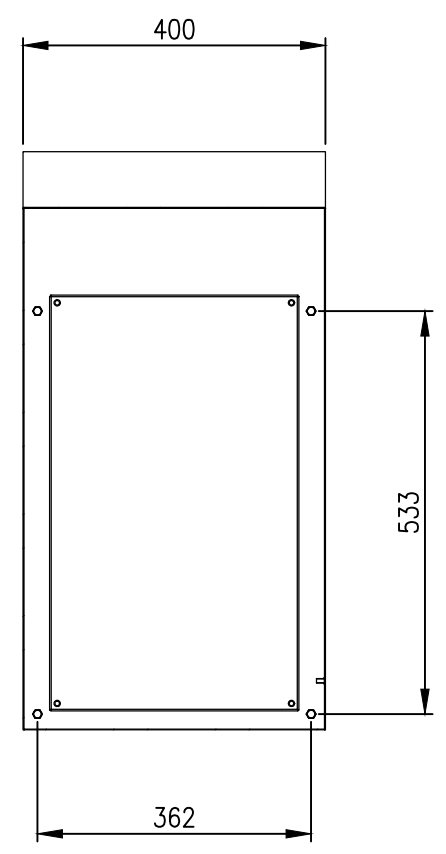

SECTION AU-AU

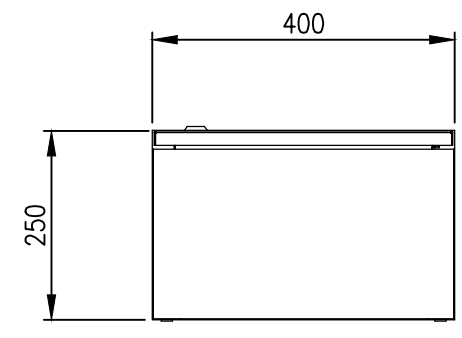
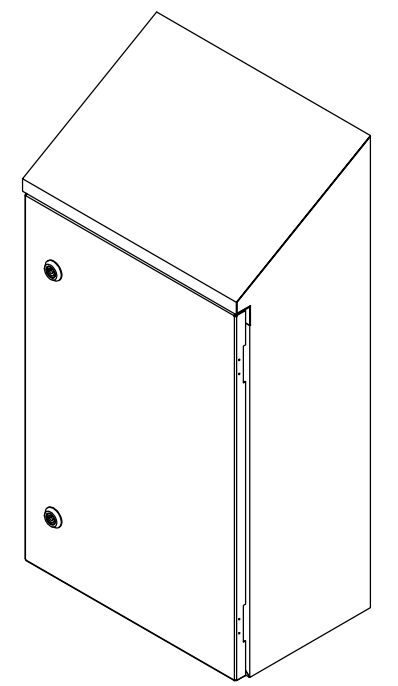

BOTTOM VIEW

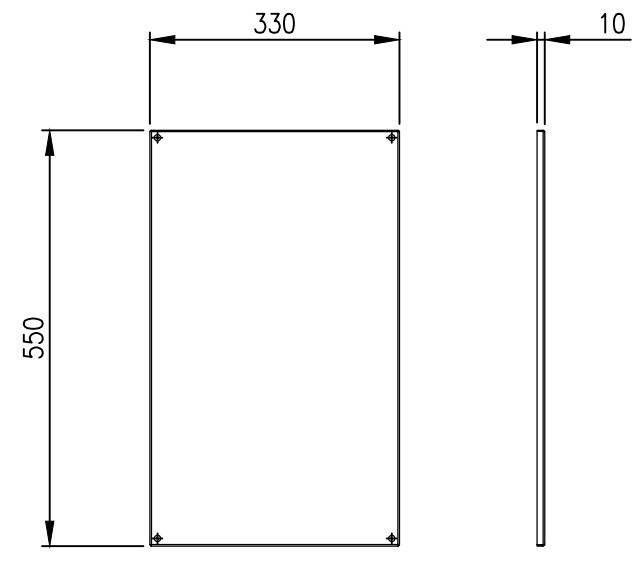

DEVICE MOUNTING PLATE

MATERIAL
 BODY: 1.2mm GALVANISED STEEL SHEET
 DOOR: 1.2mm GALVANISED STEEL SHEET
 MOUNTING PLATE: GALVANISED STEEL SHEET
 SEAL: POLYURETHANE
 COLOUR: RAL2000 ORANGE

PROTECTION: IP66 IK10, NEMA 4
 STANDARD: IEC62208, IEC/EN/AS60529

© IP ENCLOSURES 2023.
 THIS DRAWING SHALL NOT BE COPIED OR REPRODUCED
 WITHOUT AUTHORISATION FROM IP ENCLOSURES.
 www.ipenclosures.com.au

Itemref	Quantity	Title/Name, designation, material, dimension etc	Article No./Reference
Designed by IP	Checked by IP	Approved by - date 24/01/23	Filename IP-SSR604025-OR
		Date 24/01/23	Scale 1:10
IP Enclosures		600x400x250 STEEL SLOPING ROOF ENCLOSURE	
		IP-SSR604025-OR	Edition 0
			Sheet 1/1