

SSR1 Electrical Enclosure IP-SSR604025-OR

STEEL | SLOPING ROOF | SINGLE DOOR | IP66

600H x 400W x 250D

IP Enclosures SSR1 range of steel sloping roof electrical enclosures are designed to house a variety of electrical switch and control equipment while preventing build up of dust, debris and waste material.

Protection: Complies with IP66 IK10, NEMA 4x

Standard: IEC62208, IEC/EN/AS60529, RoHS  

Material:

- Body: 1.2mm Galvanised Steel Sheet
- Door: 1.2mm Galvanised Steel Sheet
- Device Mounting Plate: 1.5mm Galvanised Steel Sheet
- Seal: Polyurethane. UL listed.

Body: The robust monoblock body with sloping roof is fabricated using 1.2mm galvanised steel sheet. Flat face sealing surfaces are provided to increase seal life. Pre-fitted blind nutserts are incorporated to accommodate mounting. The roof consists of a sloped roof design that protrudes past the seal, flush with the door face.

Door: The robust surface mounted door is fabricated using 1.2mm galvanised steel sheet and incorporates concealed removable hinges with captive pins. The door is designed for a 110° opening. Each door contains cable management rails, an M6 earth stud and a high quality machine-applied foamed in place (FIP) Polyurethane seal.

Seal: UL listed Polyurethane seal foamed in place (FIP). Temperature resistance -40°C to 80°C.

Lock: Chrome 5mm double bit insert quarter turn lock with key.

Device Mounting Plate: The device mounting plate is fabricated using 1.5mm galvanised steel sheet, pressed to provide additional strength and supplied pre-fitted into enclosure as standard.

Surface Treatment: Powder-coated 80-120 micron average thickness textured finish.

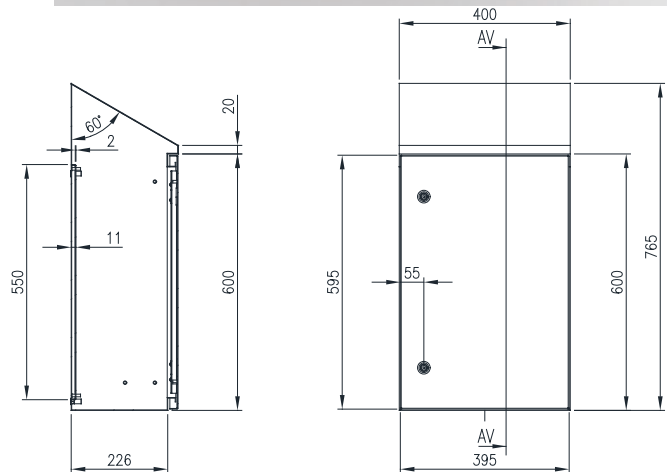

SECTION AV-AV

FRONT VIEW

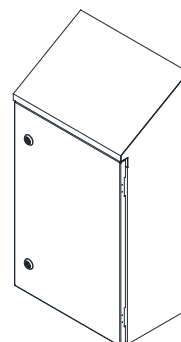

BOTTOM VIEW

