

SECTION AV-AV

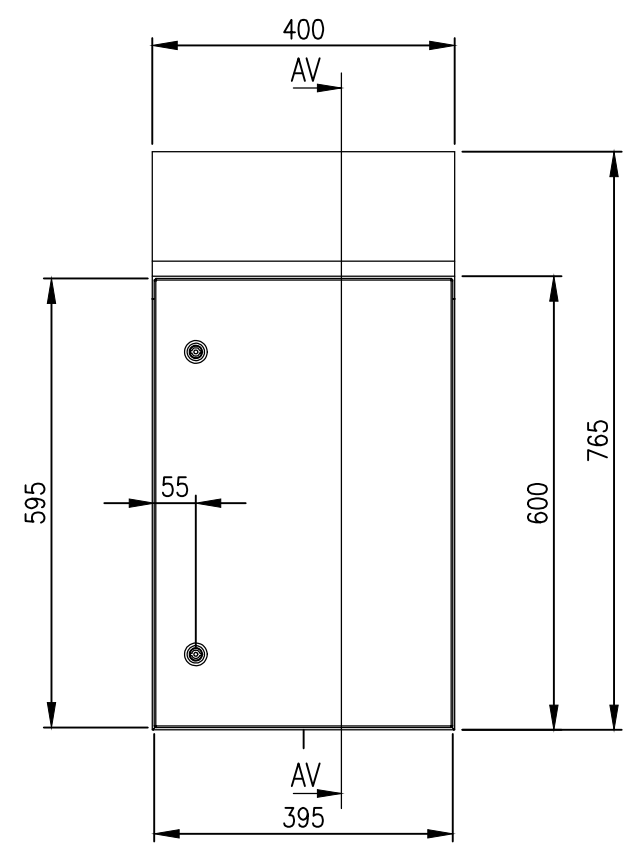

FRONT VIEW

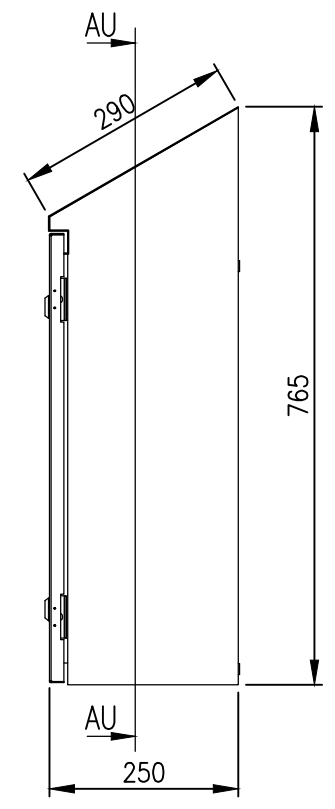

RIGHT SIDE VIEW

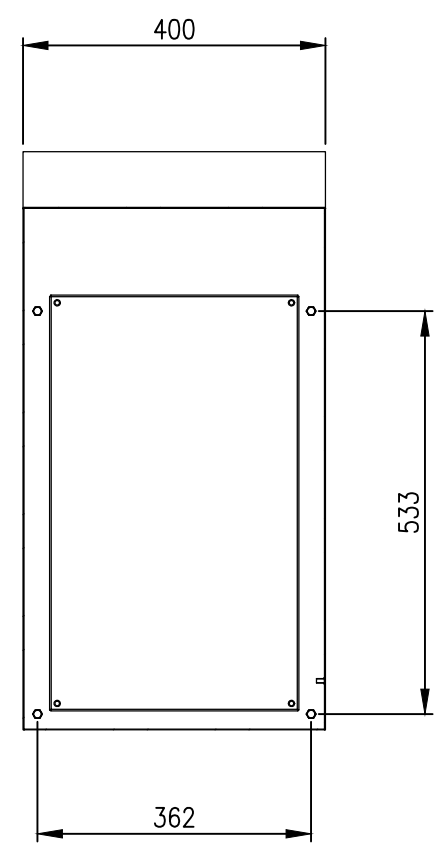

SECTION AU-AU

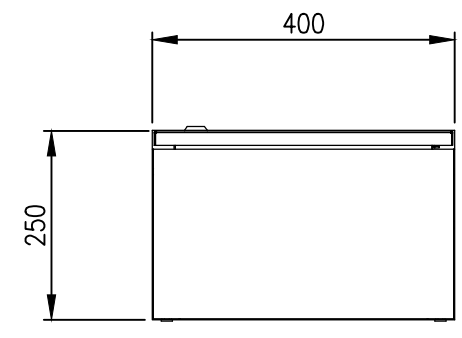
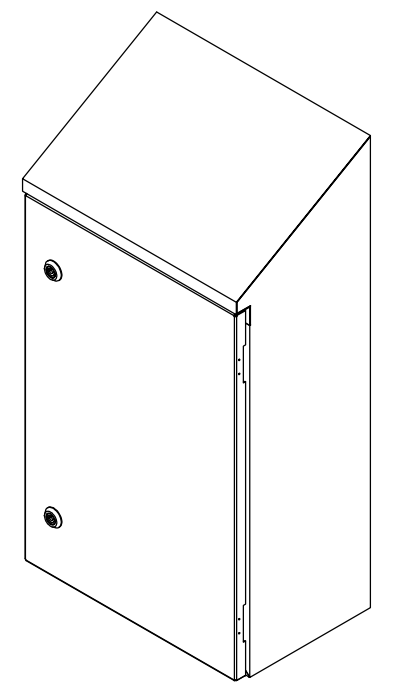

BOTTOM VIEW

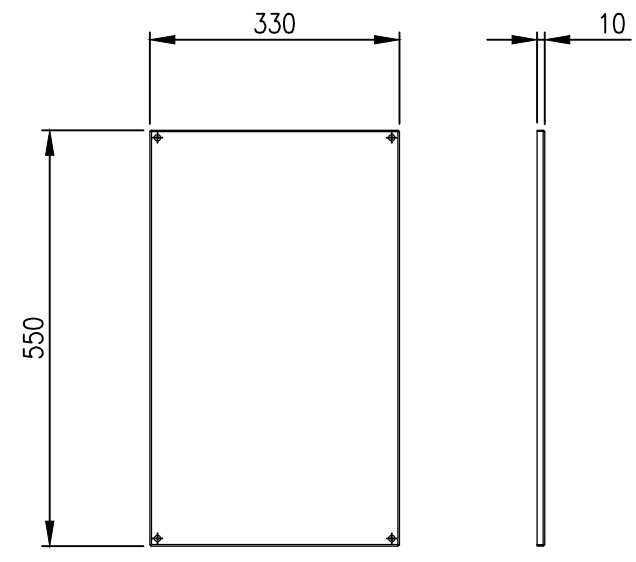

DEVICE MOUNTING PLATE

**MATERIAL**  
 BODY: 1.2mm GALVANISED STEEL SHEET  
 DOOR: 1.2mm GALVANISED STEEL SHEET  
 MOUNTING PLATE: GALVANISED STEEL SHEET  
 SEAL: POLYURETHANE  
 COLOUR: RAL7035 GREY

PROTECTION: IP66 IK10, NEMA 4  
 STANDARD: IEC62208, IEC/EN/AS60529

© IP ENCLOSURES 2023.  
 THIS DRAWING SHALL NOT BE COPIED OR REPRODUCED  
 WITHOUT AUTHORISATION FROM IP ENCLOSURES.  
 www.ipenclosures.com.au

Itemref	Quantity	Title/Name, designation, material, dimension etc	Article No./Reference
Designed by IP	Checked by IP	Approved by - date 24/01/23	Filename IP-SSR604025
		Date 24/01/23	Scale 1:10
			600x400x250 STEEL SLOPING ROOF ENCLOSURE
IP-SSR604025			Edition 0
			Sheet 1/1