

SECTION AV-AV

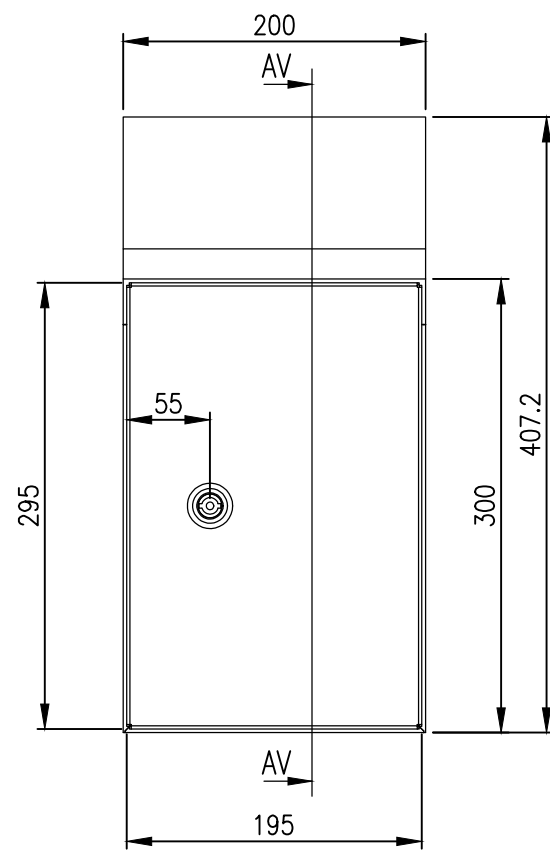

FRONT VIEW

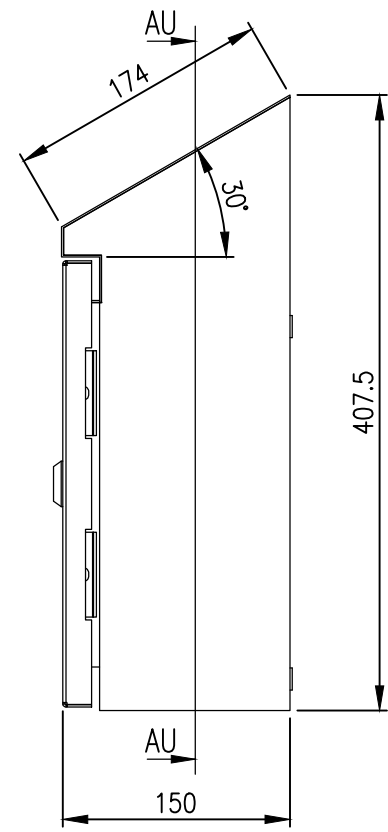

RIGHT SIDE VIEW

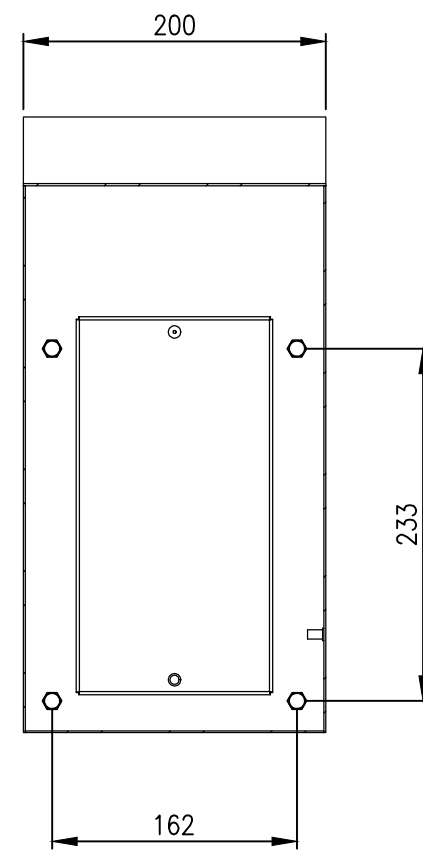

SECTION AU-AU

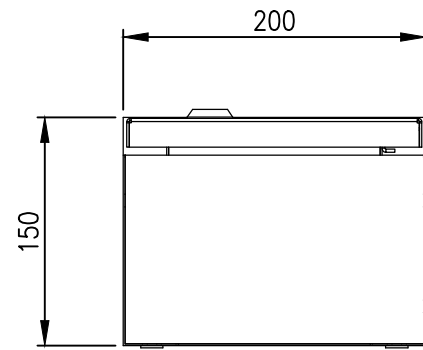
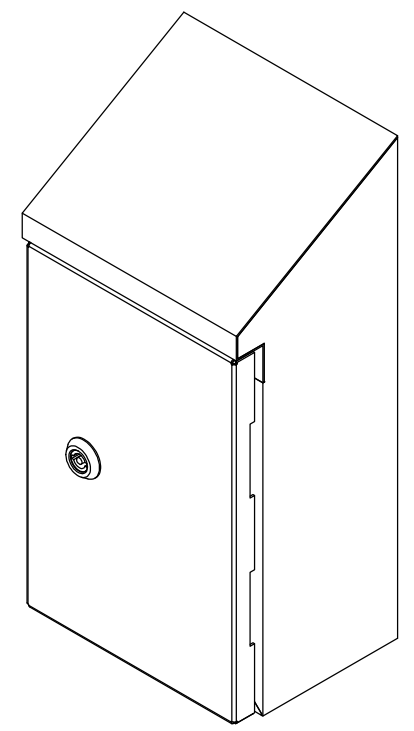

BOTTOM VIEW

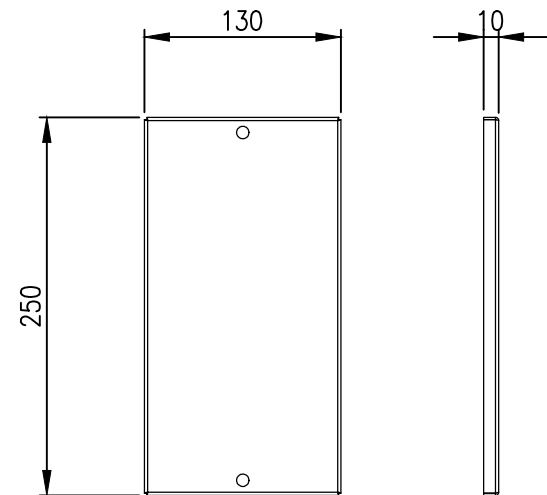

DEVICE MOUNTING PLATE

**MATERIAL**  
 BODY: 1.2mm GALVANISED STEEL SHEET  
 DOOR: 1.2mm GALVANISED STEEL SHEET  
 MOUNTING PLATE: GALVANISED STEEL SHEET  
 SEAL: POLYURETHANE  
 COLOUR: RAL2000 ORANGE

PROTECTION: IP66 IK10, NEMA 4  
 STANDARD: IEC62208, IEC/EN/AS60529

© IP ENCLOSURES 2023.  
 THIS DRAWING SHALL NOT BE COPIED OR REPRODUCED WITHOUT  
 AUTHORISATION FROM IP ENCLOSURES.  
 www.ipenclosures.com.au

Itemref	Quantity	Title/Name, designation, material, dimension etc	Article No./Reference
Designed by IP	Checked by IP	Approved by - date 23/01/23	Filename IP-SSR302015-OR
		Date 23/01/23	Scale 1:5
			300x200x150 STEEL SLOPING ROOF ENCLOSURE
IP-SSR302015-OR			Edition 0
			Sheet 1/1