

RevNo	Revision note	Date	Signature	Checked
0	GENERAL REVISION		IP	IP

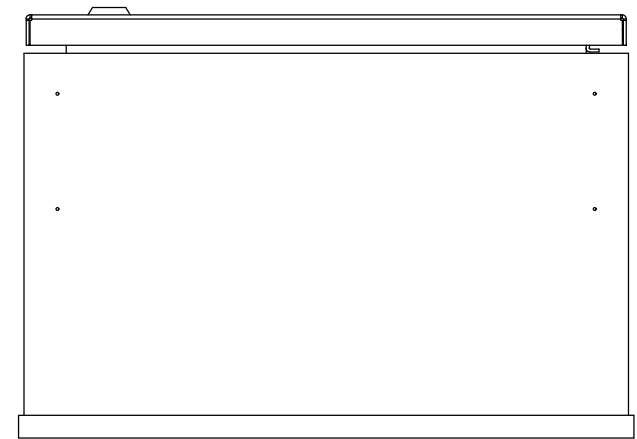

TOP VIEW

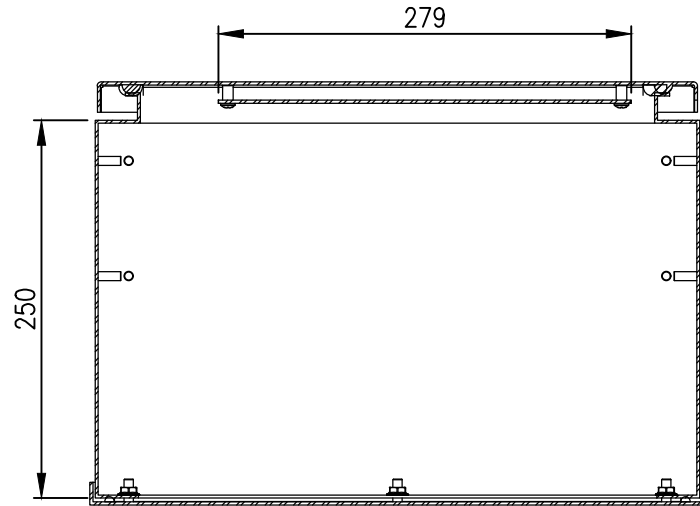

SECTION A-A

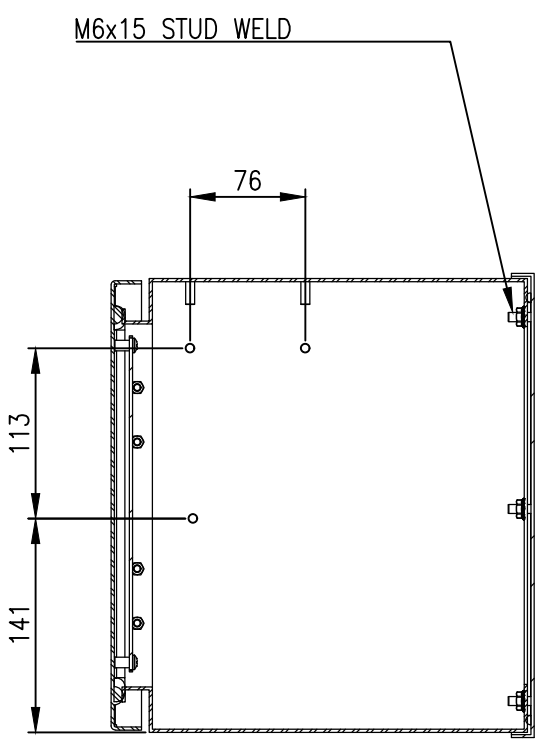

SECTION B-B

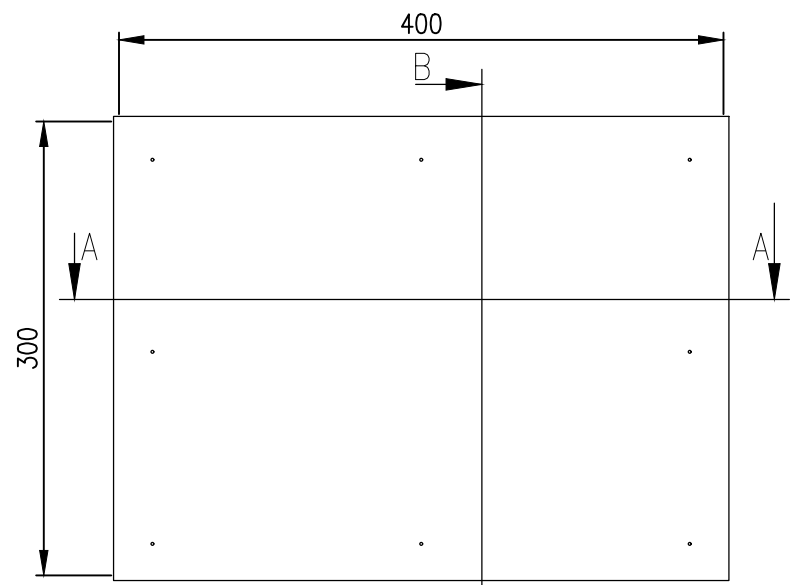

FRONT VIEW

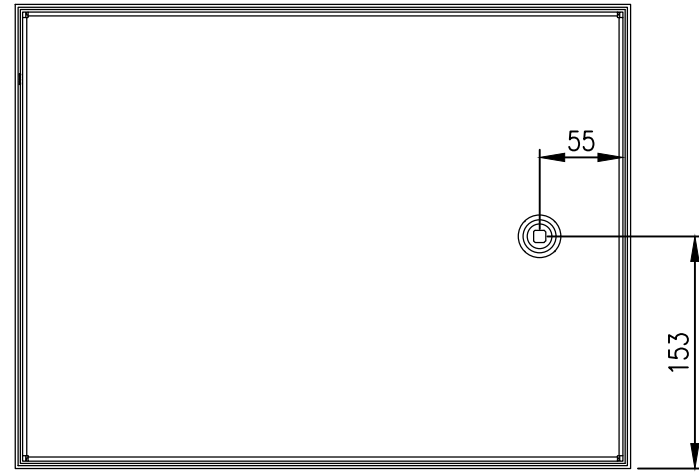

REAR VIEW

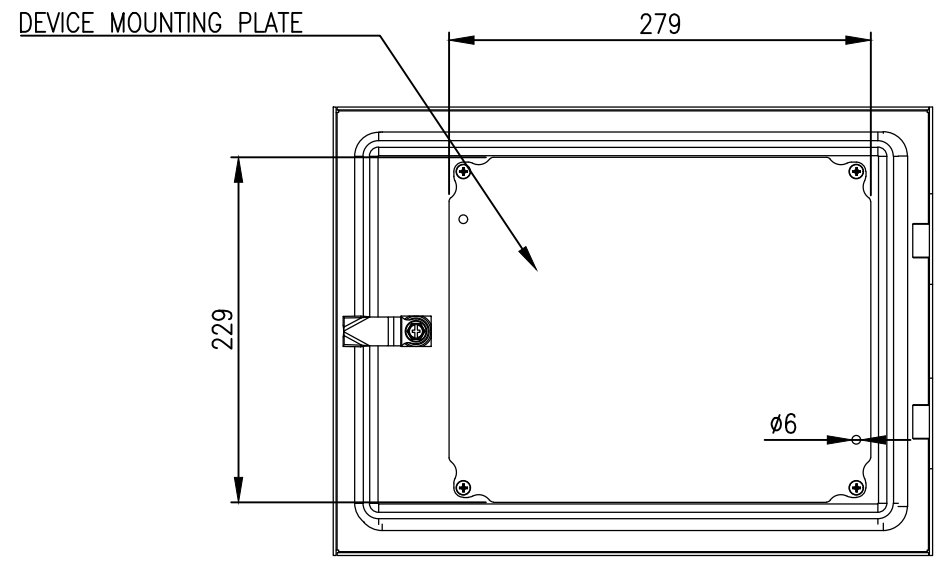
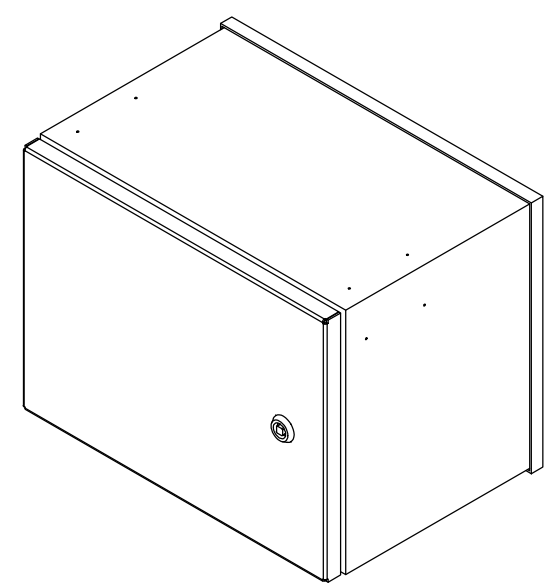

REAR-DOOR INTERIOR VIEW

MATERIAL
ENCLOSURE BODY: 2.0mm 316 STAINLESS STEEL
ENCLOSURE DOOR: 316 STAINLESS STEEL
ENCLOSURE FRONT PANEL: 316 STAINLESS STEEL
ENCLOSURE SEAL: POLYURETHANE

PROTECTION: IP66
STANDARD: AS/EN/IEC60529

© IP ENCLOSURES 2022.
THIS DRAWING SHALL NOT BE COPIED OR REPRODUCED WITHOUT
AUTHORISATION FROM IP ENCLOSURES.
www.ipenclosures.com.au

Itemref	Quantity	Title/Name, designation, material, dimension etc	Article No./Reference
IP	1	300Hx400Wx250D 316SS HMI ENCLOSURE	IP-SSHMI304025
Designed by	Checked by	Approved by - date	Filename
IP	IP	15/08/22	IP-SSHMI304025
Date	Scale	Edition	Sheet
15/08/22	1:5	0	1/1