

RevNo	Revision note	Date	Signature	Checked
1	GENERAL REVISION	15/11/22	IP	IP

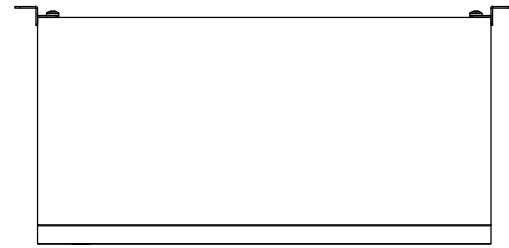

PLAN

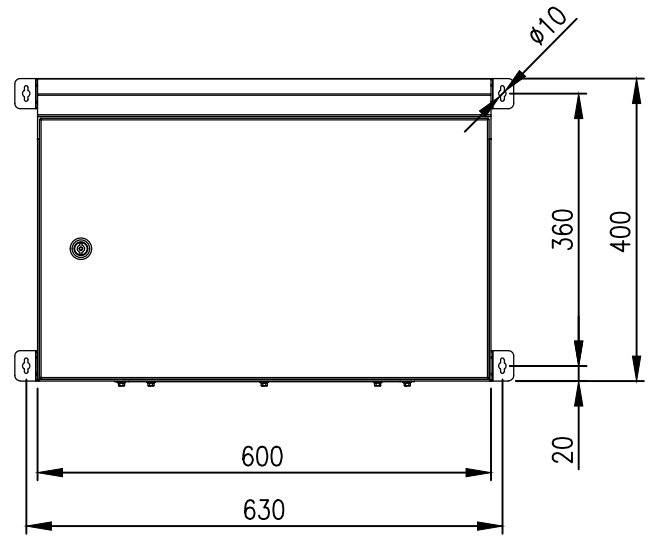
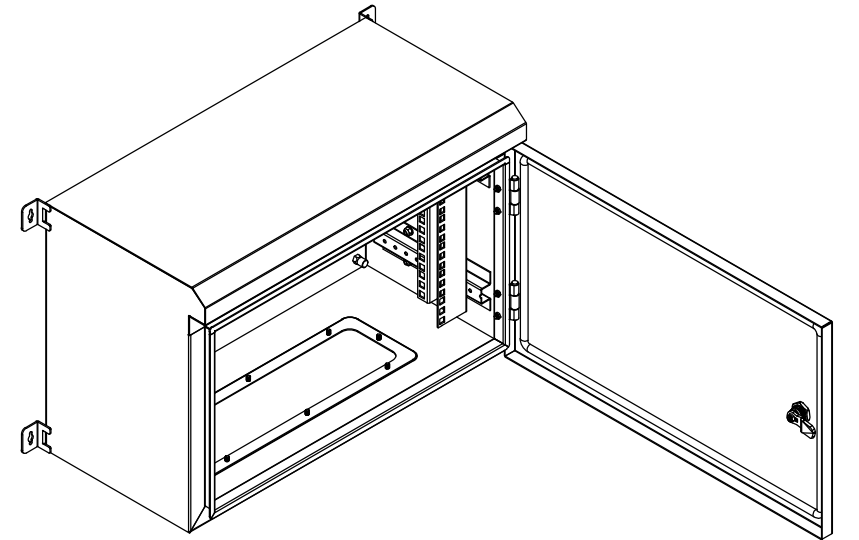

FRONT VIEW

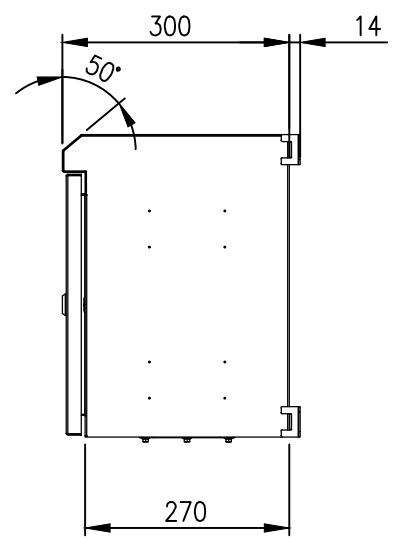

SIDE VIEW

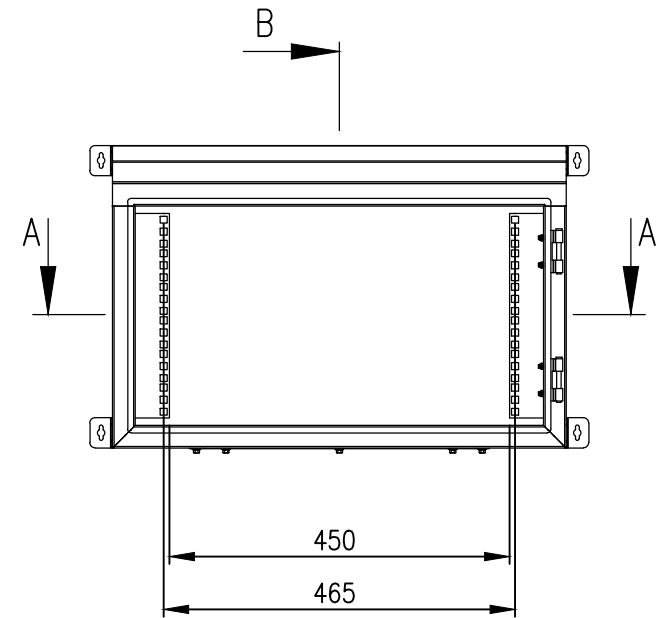

FRONT VIEW - DOOR REMOVED

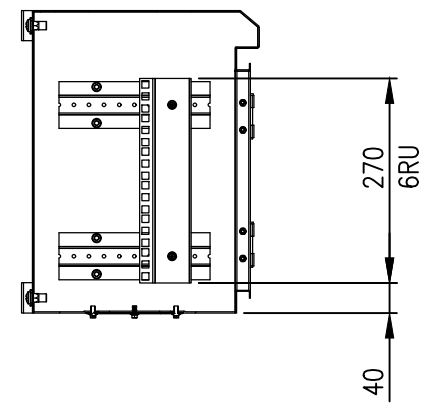

SECTION BB

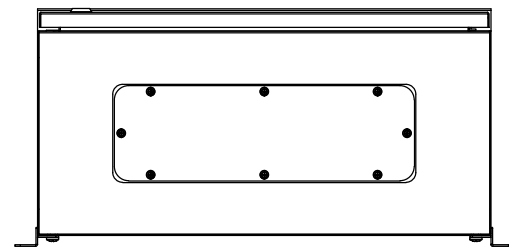

BOTTOM VIEW

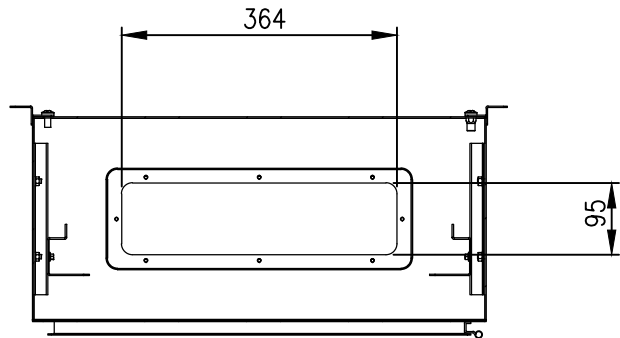

SECTION AA

MATERIAL
 BODY: 1.5mm GRADE 316 STAINLESS STEEL
 DOOR: 1.5mm GRADE 316 STAINLESS STEEL
 19" RAILS: 1.5mm GALVANISED STEEL SHEET
 SEAL: POLYURETHANE

PROTECTION: IP66 IK10
STANDARD: EIA-310-D, IEC/EN/AS60529

© IP ENCLOSURES 2016.
 THIS DRAWING SHALL NOT BE COPIED OR REPRODUCED
 WITHOUT AUTHORISATION FROM IP ENCLOSURES.
 www.ipenclosures.com.au

Itemref	Quantity	Title/Name, designation, material, dimension etc	Article No./Reference
Designed by IP	Checked by IP	Approved by - date 03/08/21	Filename IP-SSDW6U30
		Date 03/08/21	Scale 1:10
			316SS 6U 19" DATA RACK 300 DEEP
IP-SSDW6U30			Edition 1
			Sheet 1/1