

SSD 19" Data Rack

IP-SSD1606060

316 STAINLESS STEEL | SINGLE DOOR | IP66

19" 32RU - 1550H x 600W x 600D

IP Enclosures SSD range of stainless steel floor standing IP66 19" data racks are designed to house sensitive data network equipment in harsh environments. They are suitable for internal and external installations. All IP Enclosures are built to precision to ensure consistent high quality standards.

Protection: IP66 IK10

Standards (& Conformities): IEC/EN 60529, IEC/EN 62208, EIA-310-D, RoHS



Rack Unit Size: 32RU

Material:

- Enclosure Body: 1.5mm Grade 316L stainless steel
- Enclosure Door: 1.5mm Grade 316 stainless steel
- 19" Data Rack Rails: 1.5mm galvanised steel sheet
- Gland Plate: 1.5mm galvanised steel sheet
- Door Seal: Polyurethane

Surface Finish: 0.4 micron Ra surface brushed finish

Body: The robust monoblock body is fabricated using 1.5mm Grade 316L Stainless Steel. Cutting, pressing and full continuous seam welding using precision automated manufacturing equipment to ensure accuracy and consistent high quality. Flat face sealing surfaces are provided to increase seal life. A stainless steel gland plate is also incorporated into the bottom face.

Door: The robust surface mounted door is fabricated using 1.5mm Grade 316L Stainless Steel and incorporates concealed removable hinges with captive pins. The door is designed for a 110° opening. Each door contains integral cable management rail studs, M6 earth stud and a high quality machine-applied foamed in place (FIP) Polyurethane seal. Two internal cable management rails can be removed to provide additional space for equipment, duct and door mounted control components.

19" Data Rack Rails: Front and rear 19" data rack rails are fabricated from 1.5mm galvanised steel sheet.

Door Seal: A high quality machine-applied full perimeter UL listed Polyurethane seal foamed in place (FIP) provides excellent sealing over a long life. Temperature resistance -40°C to 80°C (160°C short term loading).

Lock: 3 point locking system with key-lock swing handle. A full range of locking solutions are available upon request.

Gland Plate: Gland plate is incorporated into the bottom face of the enclosure for cable management. It is provided with gaskets and fasteners. The size and quantity vary according to enclosure size.

Mass: 73.0Kg.

Maximum Weight of Contents: 640.0Kg.

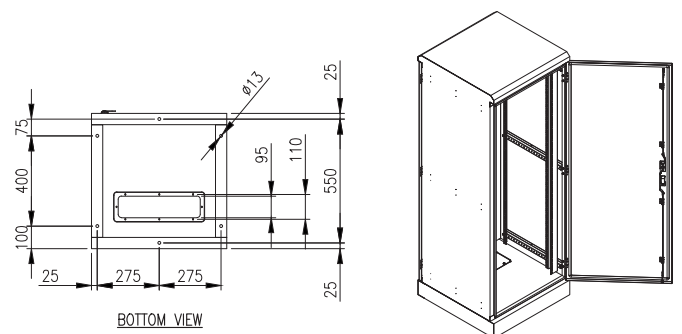
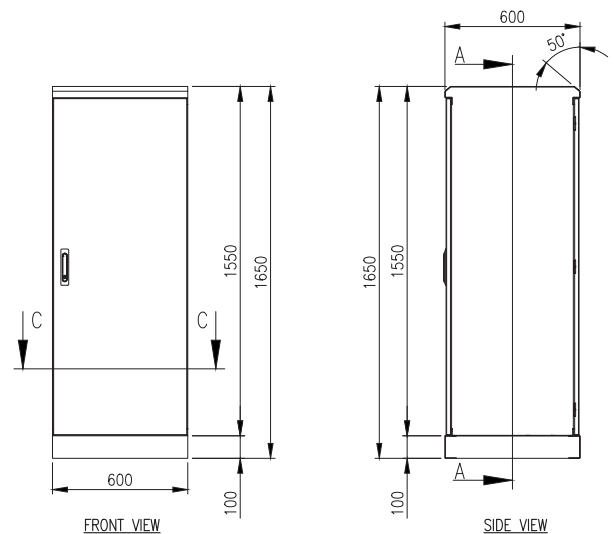

SSD 19" Data Rack

IP-SSD1606060

316 STAINLESS STEEL | SINGLE DOOR | IP66

19" 32RU - 1550H x 600W x 600D

ACCESSORIES:

Part Number	Description
IP-SDDINPANEL1	1RU 19" DIN Terminal Rail
IP-SDCOVER1	1RU 19" Cover Panel
IP-EMH1	1RU 19" Cover Panel (Ventilated)
IP-SDDINPANEL2	2RU 19" DIN Terminal Rail
IP-SDCOVER2	2RU 19" Cover Panel
IP-EMH2	2RU 19" Cover Panel (Ventilated)
IP-SDDINPANEL3	3RU 19" DIN Terminal Rail
IP-SDCOVER3	3RU 19" Cover Panel
IP-EMH3	3RU 19" Cover Panel (Ventilated)
IP-SDDP3	3RU 19" Distribution Board (Supplied with Cover Panel)
IP-SDDINBOX4RU	4RU 19" Rack Mounted DIN Rail Housing
IP-SDBOX4RU	4RU 19" Rack Mount Housing
IP-SDDINBOX6RU	6RU 19" Rack Mounted DIN Rail Housing
IP-SDBOX6RU	6RU 19" Rack Mount Housing
IP-SDDINBOX8RU	8RU 19" Rack Mounted DIN Rail Housing
IP-SDBOX8RU	8RU 19" Rack Mount Housing
IP-RCLF120	1RU 19" Fixed Shelf; 200mmD
IP-RCLF130	1RU 19" Fixed Shelf; 300mmD
IP-RCLF140	1RU 19" Fixed Shelf; 400mmD
IP-RCLF240	2RU 19" Fixed Shelf; 400mmD
IP-RCLF340	3RU 19" Fixed Shelf; 400mmD
IP-RCHF130	1RU 19" Fixed Shelf; 300mmD
IP-RCHF140	1RU 19" Fixed Shelf; 400mmD
IP-RNG2U19	2RU Cable Organiser for Data Rack
IP-M6SCREW-CAGENUT	M6 Cage Nut and Screw for 19" Data Racks - Pack of 50

CERTIFICATES:

IEC 60529 Degrees of protection provided by enclosures: Certificate AB-0386-T 2311.14.01/00

IEC/EN 62208 Empty Enclosures for low-voltage switchgear and controlgear assemblies: Certificate 0366932-TSE-01/01

CE Certificate of Compliance: Certificate SZT-24 MA 33485-1

UKCA Certificate of Compliance: Certificate SZT-25 MA 38734-1

Products are manufactured to Quality, Safety and Environmental Standards.

WARRANTY: 5 years.