

SD 19" Data Rack

IP-SD2006080-RD

STEEL | FRONT & REAR SINGLE DOOR | IP66

19" 42U - 2000H x 600W x 800D

IP Enclosures SD range of floor standing IP66 19" data racks are designed for outdoor applications to house sensitive data network equipment in harsh environments. They are suitable for internal and external installations. All IP Enclosures are built to precision to ensure consistent high quality standards.

Protection: IP66 IK10

Standards (& Conformities): IEC/EN 60529, IEC/EN 62208, EIA-310-D, RoHS



Rack Unit Size: 42U

Material:

- Enclosure Body: 2.0mm galvanised steel sheet
- Enclosure Door: 2.0mm galvanised steel sheet
- 19" Data Rack Rails: 1.5mm galvanised steel sheet
- Gland Plate: 1.5mm galvanised steel sheet
- Enclosure Seal: Polyurethane. UL listed.

Body & 19" Rails: The robust monoblock body is 2.0 mm galvanised steel sheet. Precision automated manufacturing equipment ensures accuracy and consistent high quality. Flat face sealing surfaces increase seal life. A galvanised steel gland plate is also incorporated into the bottom face. 19" data rack rails are fitted.

Enclosure Doors: The front and rear surface mounted doors are 2.0mm galvanised steel sheet. They incorporate concealed removable hinges with captive pins. Doors are also designed for a 110° opening. Each door contains integral cable management rail studs and an M6 earth stud. The cable management rails are removable to provide more space for control components. (Standard range includes front door only with fixed rear panel).

Enclosure Seal: A high quality machine-applied full perimeter UL listed Polyurethane seal foamed in place (FIP) provides excellent sealing over a long life. Temperature resistance -40°C to 80°C (160°C short term loading).

Enclosure Lock: 3 point locking system with key-lock swing handle. A full range of locking solutions are available upon request.

Gland Plate: Gland plate is incorporated into the bottom face of the enclosure for cable management. It is provided with gaskets and fasteners. The size and quantity vary according to enclosure size.

Surface Treatment: UL approved AkzoNobel epoxy polyester powder-coated with a textured finish. 80-120 micron average thickness. Colour RAL7035. (Other colours available upon request).

Mass: 141.0Kg.

Maximum Weight of Contents: 840.0Kg.

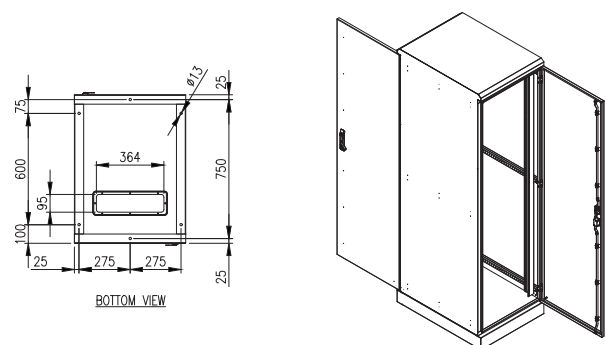
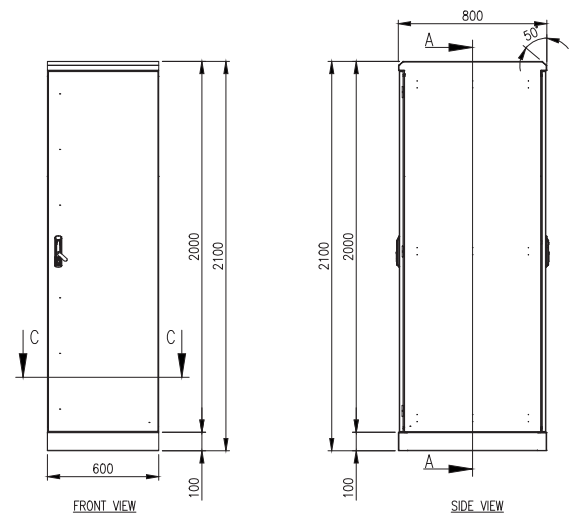

SD 19" Data Rack

IP-SD2006080-RD

STEEL | FRONT & REAR SINGLE DOOR | IP66

19" 42U - 2000H x 600W x 800D

ACCESSORIES:

Part Number	Description
IP-SDDINPANEL1	1U 19" DIN Terminal Rail
IP-SDCOVER1	1U 19" Cover Panel
IP-EMH1	1U 19" Cover Panel (Ventilated)
IP-SDDINPANEL2	2U 19" DIN Terminal Rail
IP-SDCOVER2	2U 19" Cover Panel
IP-EMH2	2U 19" Cover Panel (Ventilated)
IP-SDDINPANEL3	3U 19" DIN Terminal Rail
IP-SDCOVER3	3U 19" Cover Panel
IP-EMH3	3U 19" Cover Panel (Ventilated)
IP-SDDP3	3U 19" Distribution Board (Supplied with Cover Panel)
IP-SDDINBOX4RU	4U 19" Rack Mounted DIN Rail Housing
IP-SDBOX4RU	4U 19" Rack Mount Housing
IP-SDDINBOX6RU	6U 19" Rack Mounted DIN Rail Housing
IP-SDBOX6RU	6U 19" Rack Mount Housing
IP-SDDINBOX8RU	8U 19" Rack Mounted DIN Rail Housing
IP-SDBOX8RU	8U 19" Rack Mount Housing
IP-RCLF120	1U 19" Fixed Shelf; 200mmD
IP-RCLF130	1U 19" Fixed Shelf; 300mmD
IP-RCLF140	1U 19" Fixed Shelf; 400mmD
IP-RCLF240	2U 19" Fixed Shelf; 400mmD
IP-RCLF340	3U 19" Fixed Shelf; 400mmD
IP-RCHF130	1U 19" Fixed Shelf; 300mmD
IP-RCHF140	1U 19" Fixed Shelf; 400mmD
IP-RNG2U19	2U Cable Organiser for Data Rack
IP-M6SCREW-CAGENUT	M6 Cage Nut and Screw for 19" Data Racks - Pack of 50

CERTIFICATES:

IEC 60529 Degrees of protection provided by enclosures: Certificate AB-0386-T 2311.14.01/00

IEC/EN 62208 Empty Enclosures for low-voltage switchgear and controlgear assemblies: Certificate 0366932-TSE-01/01

CE Certificate of Compliance: Certificate SZT-24 MA 33485-1

UKCA Certificate of Compliance: Certificate SZT-25 MA 38734-1

Products are manufactured to Quality, Safety and Environmental Standards.

WARRANTY: 5 years.