

RevNo	Revision note	Date	Signature	Checked
2	GENERAL REVISION	05/06/25	IP	IP

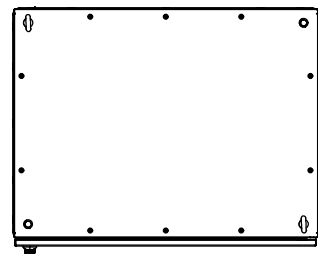

TOP VIEW

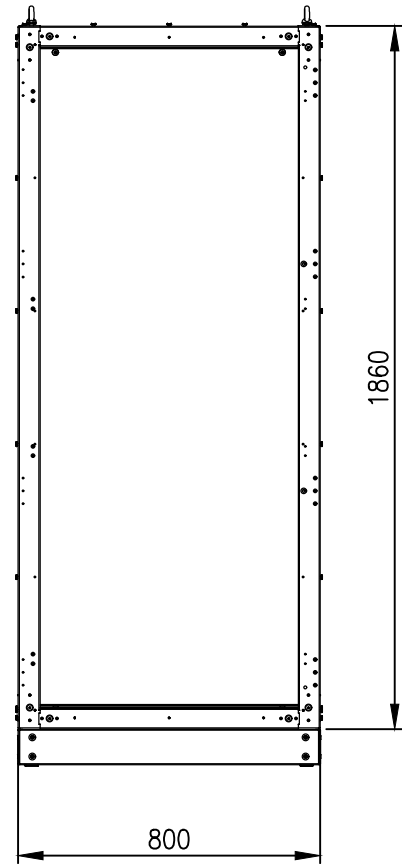

FRONT VIEW
(PANELS REMOVED)

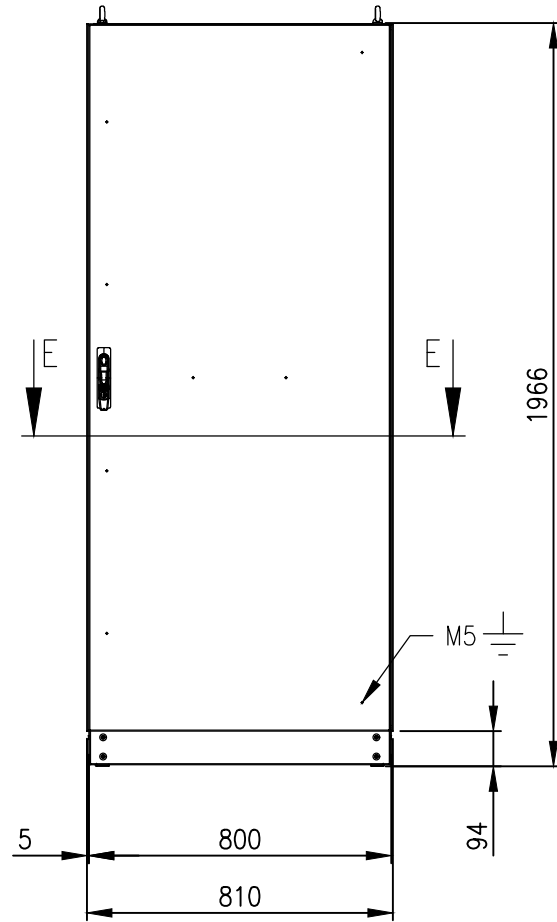

FRONT VIEW
(ASSEMBLY)

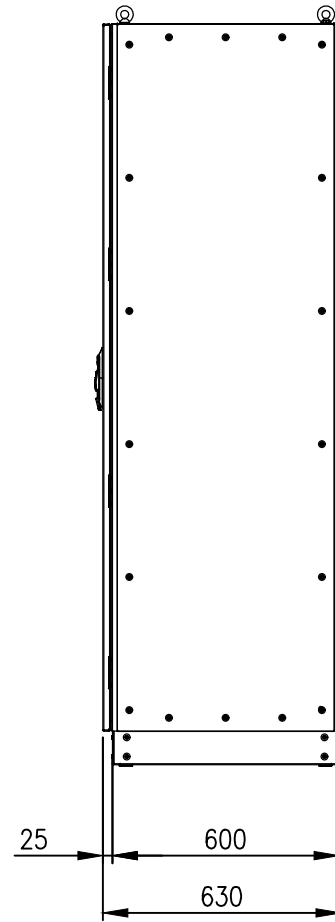

SIDE VIEW

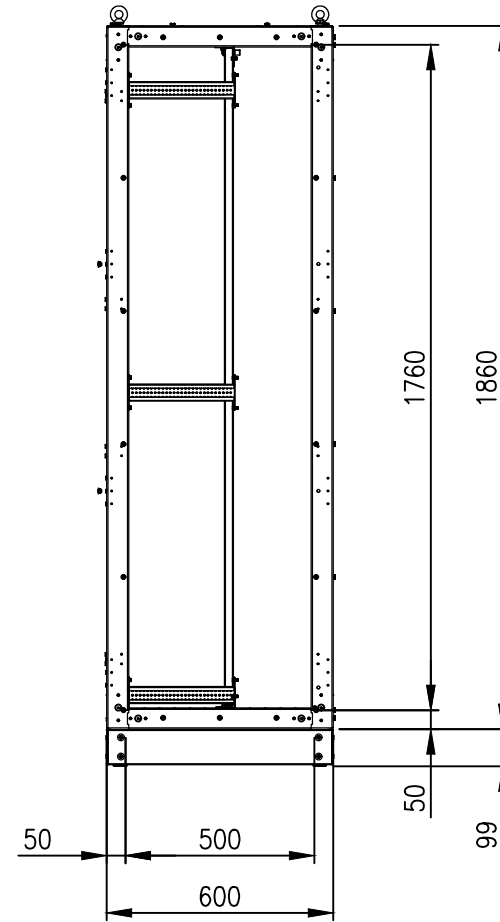

SIDE VIEW
(PANELS REMOVED)

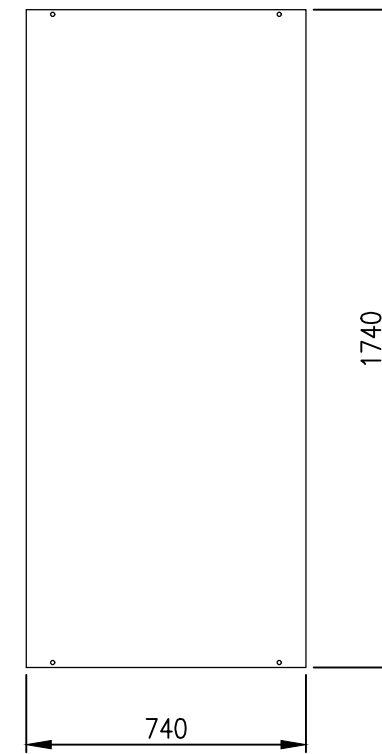

DEVICE MOUNTING PLATE

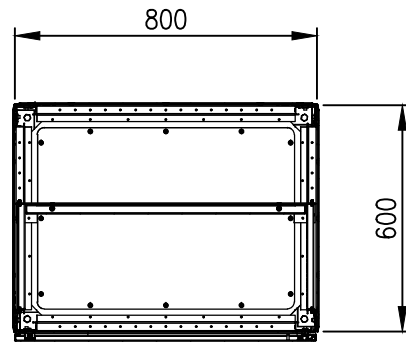
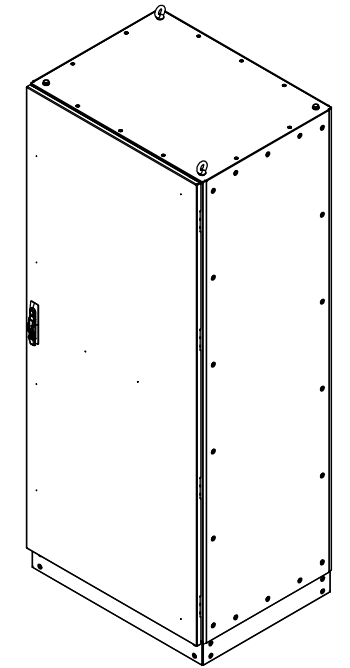

SECTION E-E

MATERIAL
 MAIN FRAME: 2.0mm GRADE 316SS PROFILE
 PANELS: 1.2mm GRADE 316 STAINLESS STEEL
 DOOR: 2.0mm GRADE 316 STAINLESS STEEL
 MOUNTING PLATE: 2.0mm GALVANISED STEEL SHEET
 SEAL: EPDM

MASS: 150Kg.

PROTECTION: IP55 IK10
 STANDARD: IEC/EN 62208, IEC/EN/AS60529
 ORDERING INFORMATION:
 - ENCLOSURE: IP-MFS1868060
 - SIDE PANEL: IP-MFSP18660
 - MOUNTING PLATE: IP-MFSM18680
 - BASE: IP-MFSB8060

© IP ENCLOSURES 2017.
 THIS DRAWING SHALL NOT BE COPIED OR REPRODUCED
 WITHOUT AUTHORISATION FROM IP ENCLOSURES.
 www.ipenclosures.com.au

Itemref	Quantity	Title/Name, designation, material, dimension etc	Article No./Reference
IP	1	1860x800x600 STEEL FREESTANDING	IP-MFS1868060
Designed by	Checked by	Approved by - date	Filename Date Scale
IP	IP	22/11/17	IP-MFS1868060 22/11/17 1:20
Edition		Sheet	
2		1/1	

