

RevNo	Revision note	Date	Signature	Checked
0	GENERAL REVISION		IP	IP

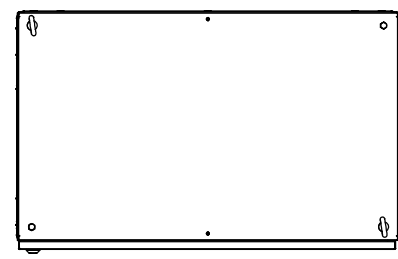

TOP VIEW

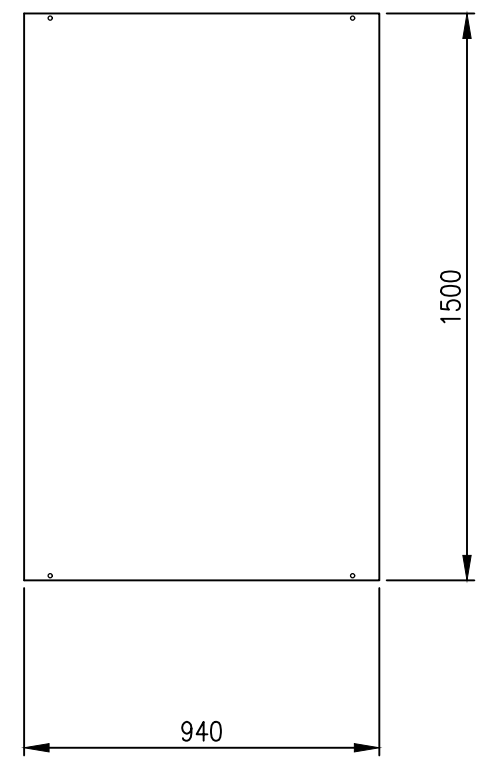

DEVICE MOUNTING PLATE

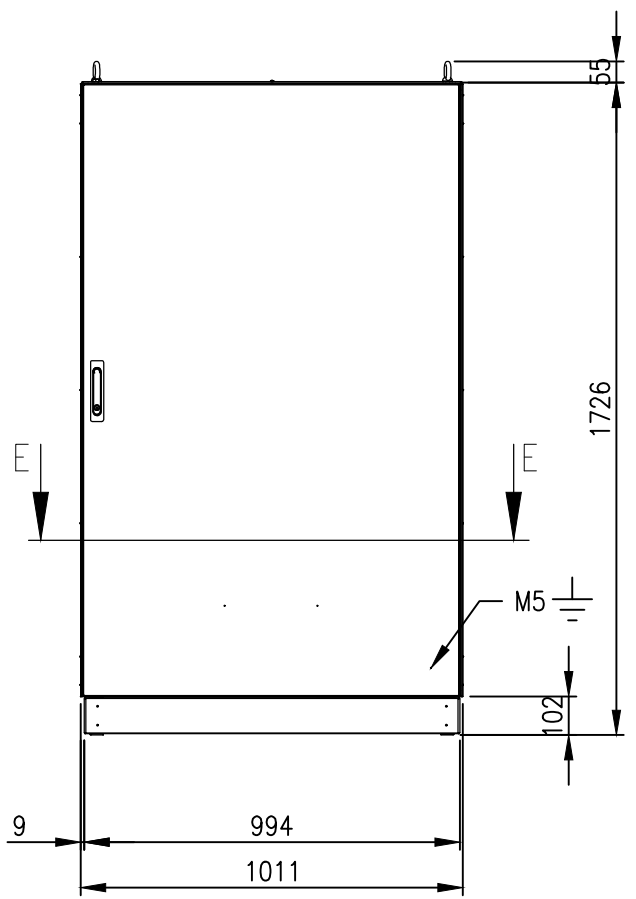
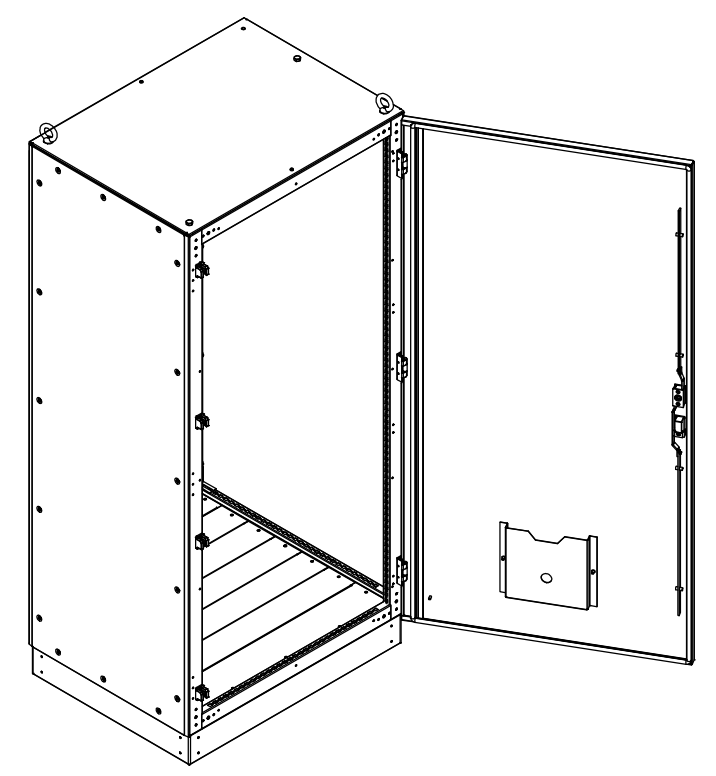

FRONT VIEW (ASSEMBLY)

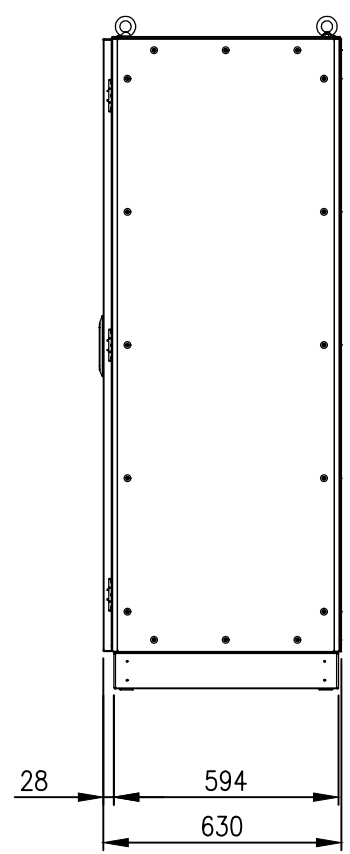

SIDE VIEW

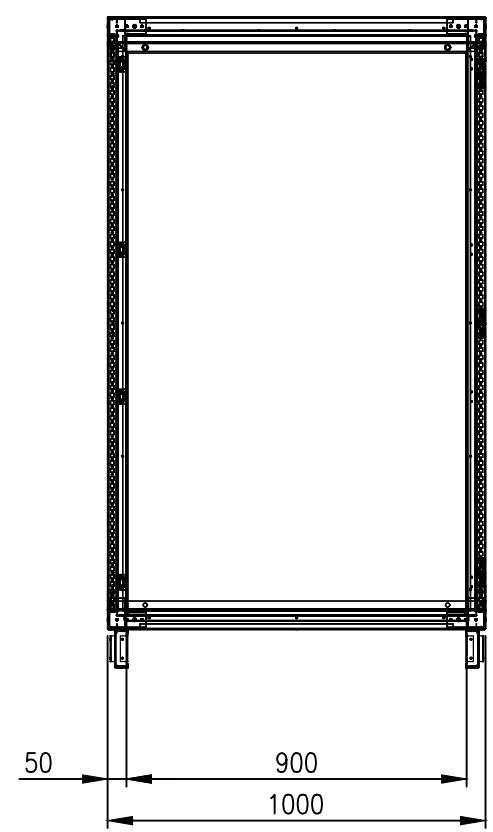

FRONT VIEW (PANELS REMOVED)

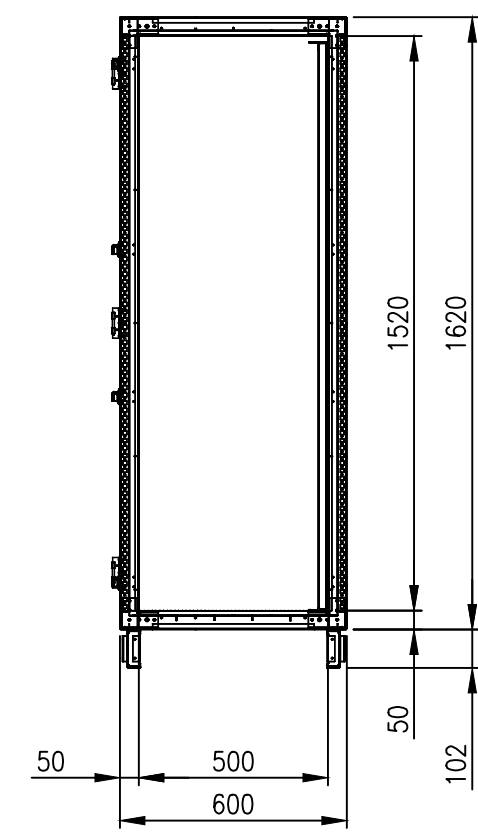

SIDE VIEW (PANELS REMOVED)

MATERIAL
 MAIN FRAME: 2.0mm GALVANISED STEEL PROFILE
 PANELS: 1.2mm POWDERCOATED GALVANISED SHEET
 DOOR: 2.0mm POWDERCOATED GALVANISED STEEL
 MOUNTING PLATE: 2.0mm GALVANISED STEEL SHEET
 SEAL: EPDM
 SURFACE TREATMENT: POWDER-COAT 80-120micron
 STANDARD COLOUR: RAL7035

PROTECTION: IP55 IK10
 STANDARD: IEC62208, IEC/EN/AS60529
 ORDERING INFORMATION:
 - ENCLOSURE: IP-MFS16210060
 - SIDE PANEL: IP-MFSP16260
 - MOUNTING PLATE: IP-MFSM162100
 - BASE: IP-MFSB10060

© IP ENCLOSURES 2024.
 THIS DRAWING SHALL NOT BE COPIED OR REPRODUCED
 WITHOUT AUTHORISATION FROM IP ENCLOSURES.
 www.ipenclosures.com.au

Itemref	Quantity	Title/Name, designation, material, dimension etc	Article No./Reference
IP	1	1620x1000x600 STEEL FREESTANDING	IP-MFS16210080
IP	1	1620x1000x600 STEEL FREESTANDING	IP-MFS16210080



1620x1000x600 STEEL FREESTANDING
 IP-MFS16210080
 Edition 1
 Sheet 1/1