

# HPB PUSHBUTTON ENCLOSURE

# IP-HPB1

304 STAINLESS STEEL | IP66, IP69K

90H x 90W x 90D

The HPB range of IP69K Pushbutton Enclosures are designed to prevent contamination and are suitable for the food & beverage, pharmaceutical and other industries.

**Protection:** IP66 IK08, IP69K, NEMA Type 1,12, 4, 4x

**Standard:** EN/AS60529, ISO20653, UL508A, RoHS Compliant



**Material:**

- Body: 1.0mm. Grade 304 stainless steel
- Cover: 1.0mm. Grade 304 stainless steel
- Seal: Blue Silicone; FDA compliant

**Body:** The body is fabricated using 1.0mm Grade 304 Stainless Steel. It is designed to be completely smooth and without crevices and without concave angles to facilitate cleaning and avoid deposits. The body is designed to promote self draining for ease of hygienic cleaning.

**Cover:** The cover is fabricated using 1.0mm Grade 304 Stainless Steel and includes a clip-in silicone seal.

**Seal:** Blue Silicone Seal, FDA compliant for food production areas.

**Accessories:** Hygienic Wall Mounting Brackets.  
SKU: IP-HWMB (Ste of 2).

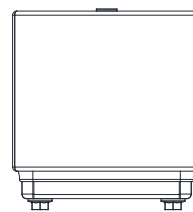

TOP VIEW

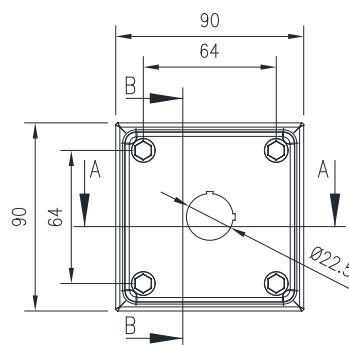
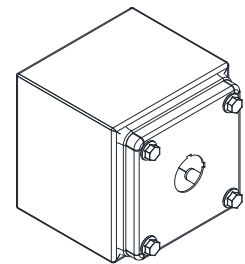

FRONT VIEW

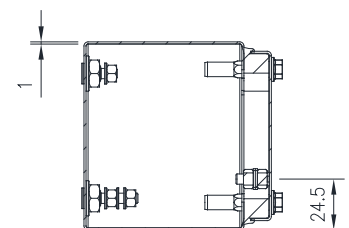

SECTION B-B