

TOP VIEW

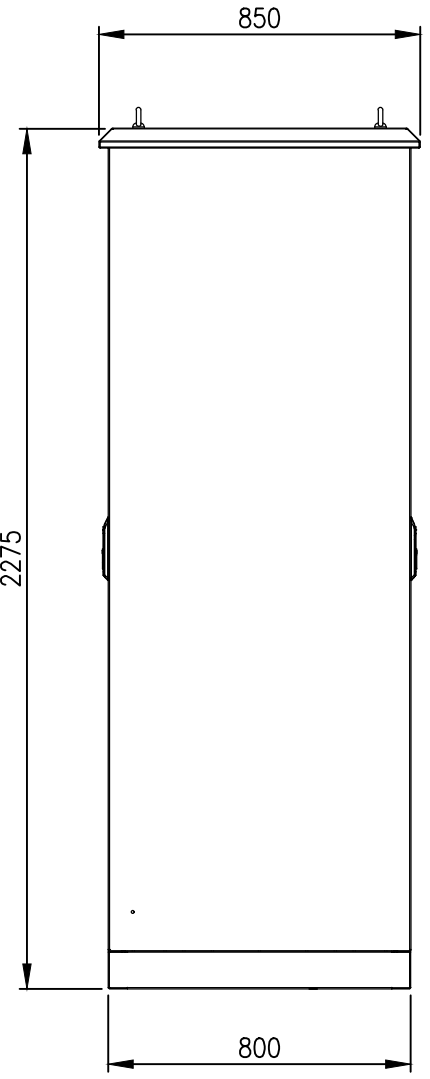

LEFT SIDE VIEW

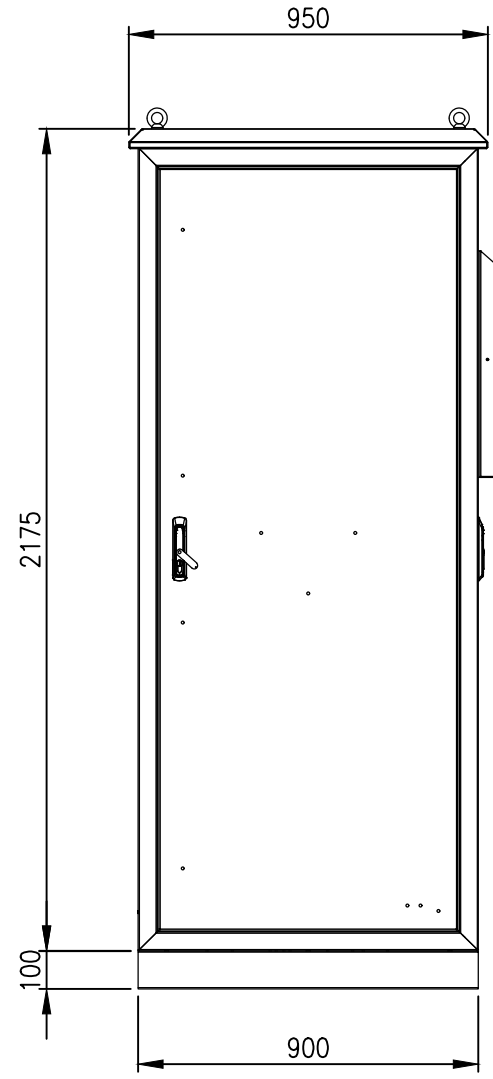

FRONT VIEW

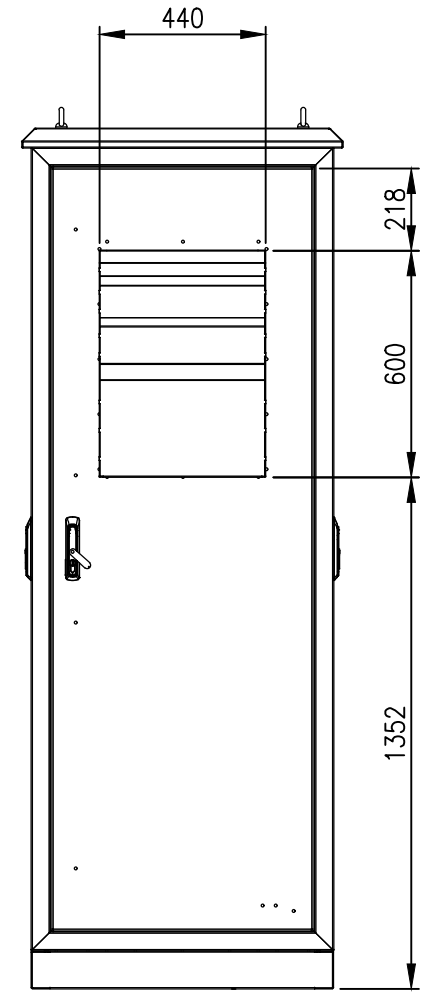

RIGHT SIDE VIEW

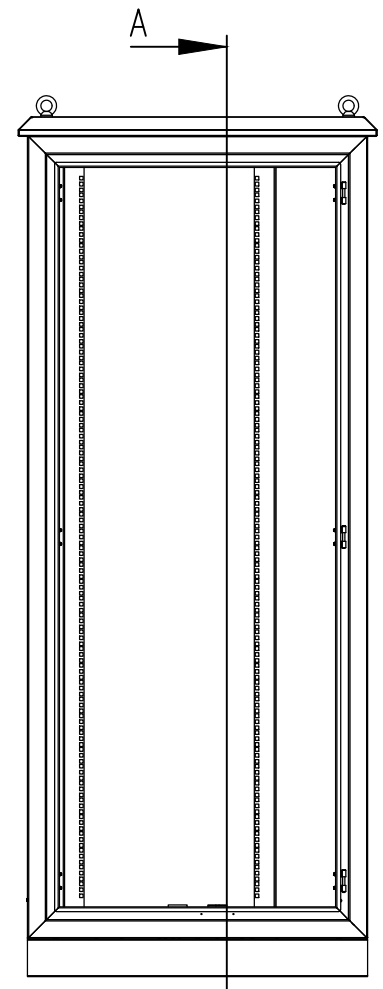

INTERIOR VIEW-DOOR REMOVED

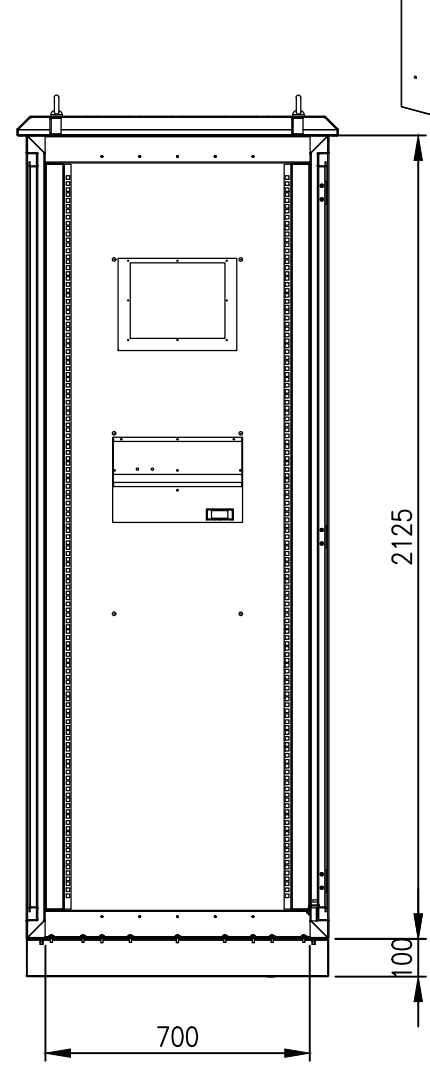

SECTION A-A

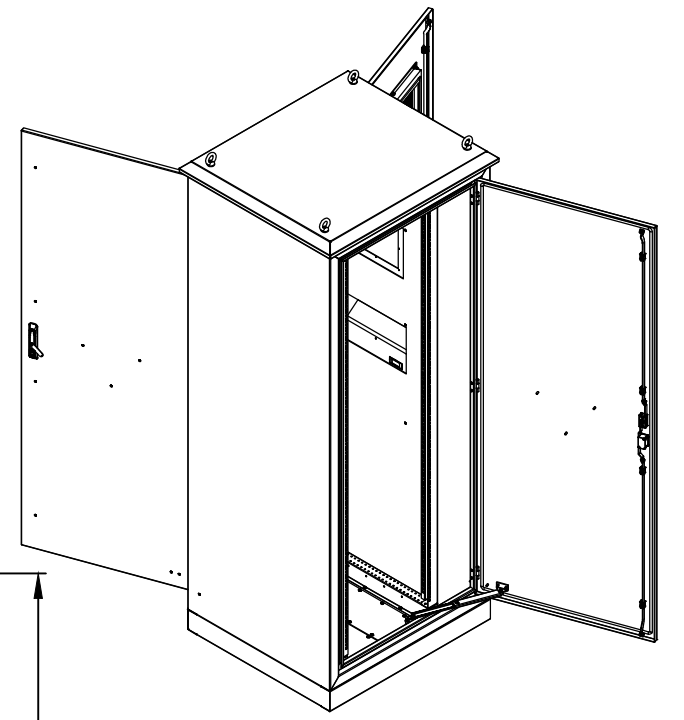

MATERIAL
 BODY AND PLINTH: 2.5mm MARINE GRADE ALUMINIUM
 DOORS: 2.5mm MARINE GRADE ALUMINIUM
 19" DATA RAILS: 1.5mm GALVANISED STEEL SHEET
 GLAND PLATE: 3.0mm ALUMINIUM
 SEAL: POLYURETHANE
 SURFACE TREATMENT: POWDER-COAT 80-120micron
 COLOUR: RAL7035 LIGHT GREY, SMOOTH FINISH

PROTECTION: IP55
 STANDARD: IEC62208, IEC/EN/AS60529, EIA-310D

© IP ENCLOSURES 2022.
 THIS DRAWING SHALL NOT BE COPIED OR REPRODUCED
 WITHOUT AUTHORISATION FROM IP ENCLOSURES.
 www.ipenclosures.com.au

Itemref	Quantity	Title/Name, designation, material, dimension etc	Article No./Reference
Designed by IP	Checked by IP	Approved by - date 16/08/22	Filename IP-A2279080-AC200
		Date 16/08/22	Scale 1:20
			42U IP55 2275Hx900Wx800D ALUM. AC FIELD CABINET
IP-A2279080-AC200			Edition 0
			Sheet 1/1