

TOP VIEW

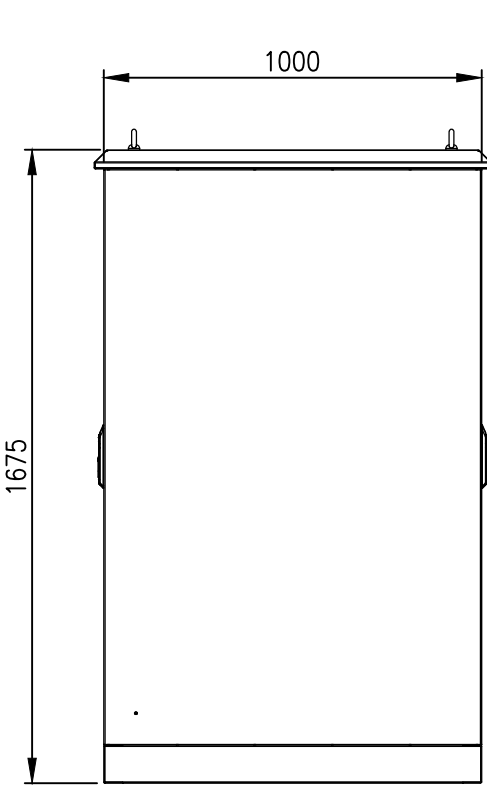

LEFT SIDE VIEW

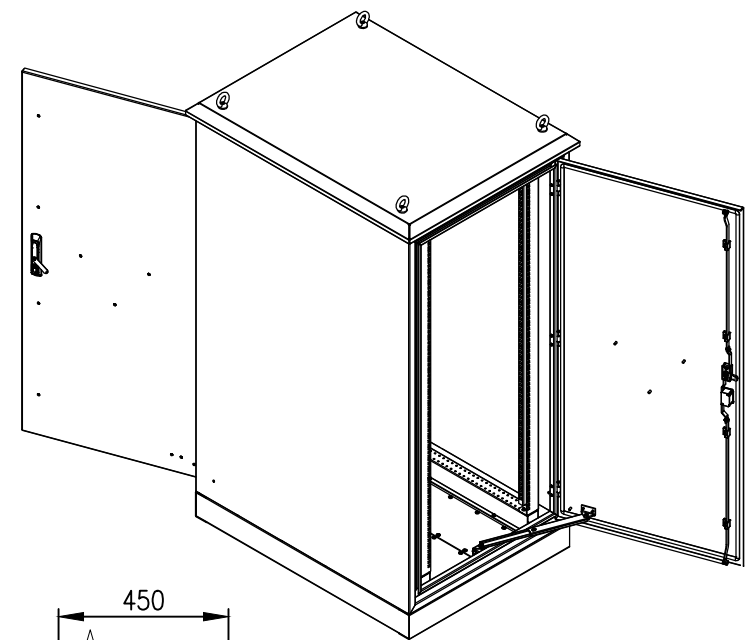
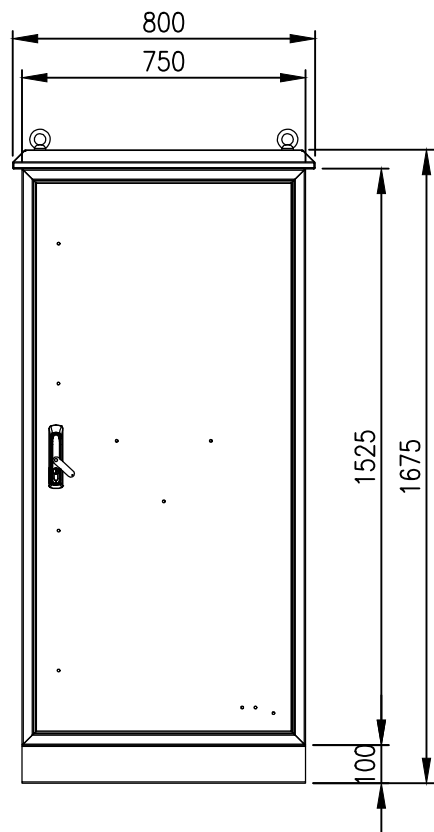

FRONT VIEW

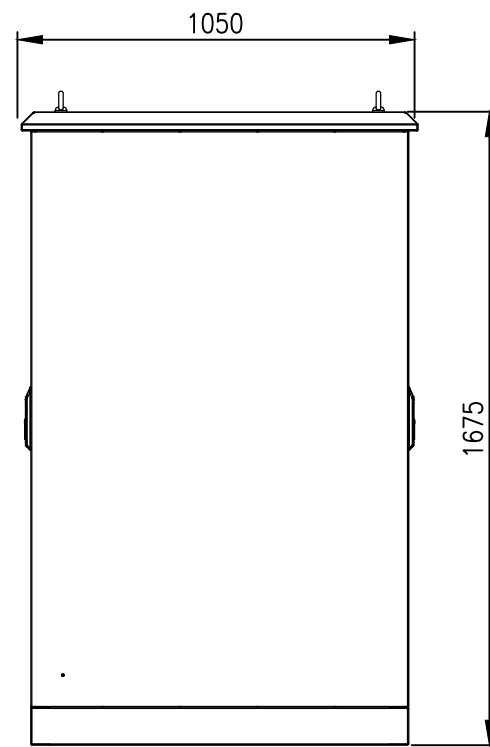

RIGHT SIDE VIEW

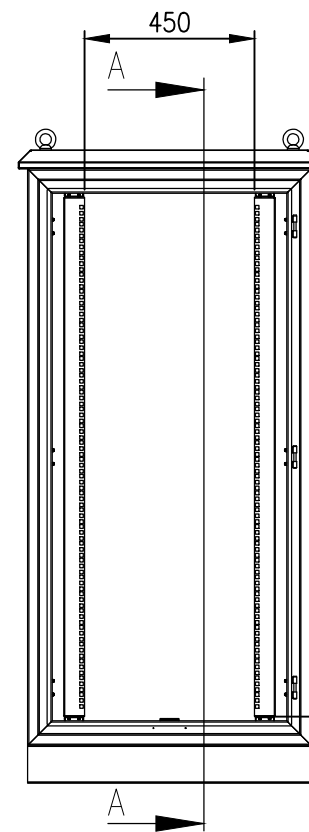

FRONT INTERIOR VIEW
(DOOR REMOVED)

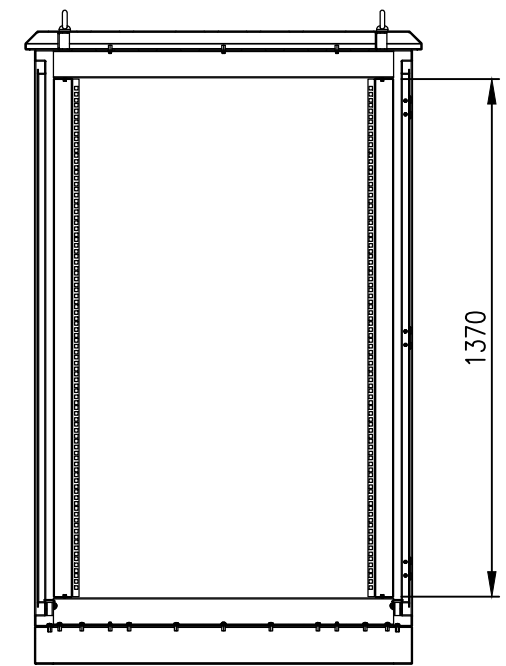

SECTION A-A

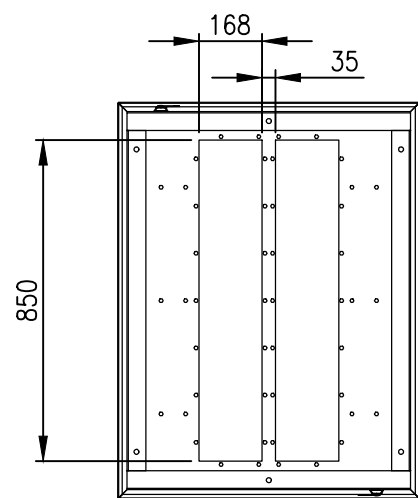

BOTTOM VIEW

MATERIAL
 BODY AND PLINTH: 2.5mm MARINE GRADE ALUMINIUM
 DOORS: 2.5mm MARINE GRADE ALUMINIUM
 19" DATA RAILS: 1.5mm GALVANISED STEEL SHEET
 GLAND PLATE: 3.0mm ALUMINIUM
 SEAL: POLYURETHANE
 SURFACE TREATMENT: POWDER-COAT 80-120micron
 COLOUR: RAL7035 GREY, SMOOTH FINISH

PROTECTION: IP66
 STANDARD: IEC62208, IEC/EN/AS60529, EIA-310D

© IP ENCLOSURES 2023.
 THIS DRAWING SHALL NOT BE COPIED OR REPRODUCED
 WITHOUT AUTHORISATION FROM IP ENCLOSURES.
 www.ipenclosures.com.au

Itemref	Quantity	Title/Name, designation, material, dimension etc			Article No./Reference	
Designed by IP	Checked by IP	Approved by - date 16/02/23	Filename IP-A16775100-0	Date 16/02/23	Scale 1:20	
				30U ALUMINIUM 1675x750x1000 (NO VENTS)		
				IP-A16775100-0	Edition 0	Sheet 1/1