

TOP VIEW

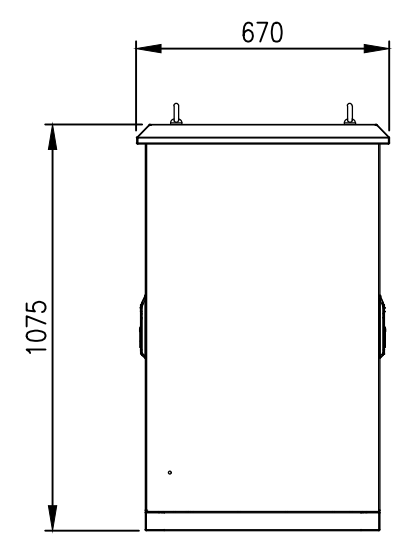

LEFT SIDE VIEW

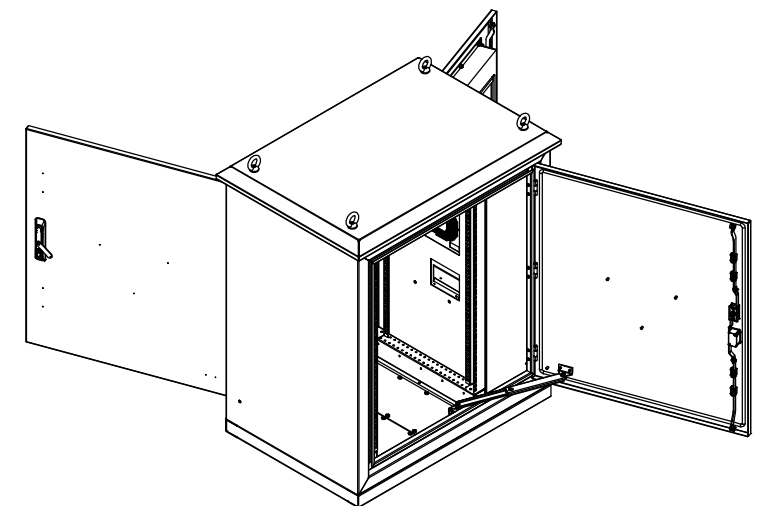
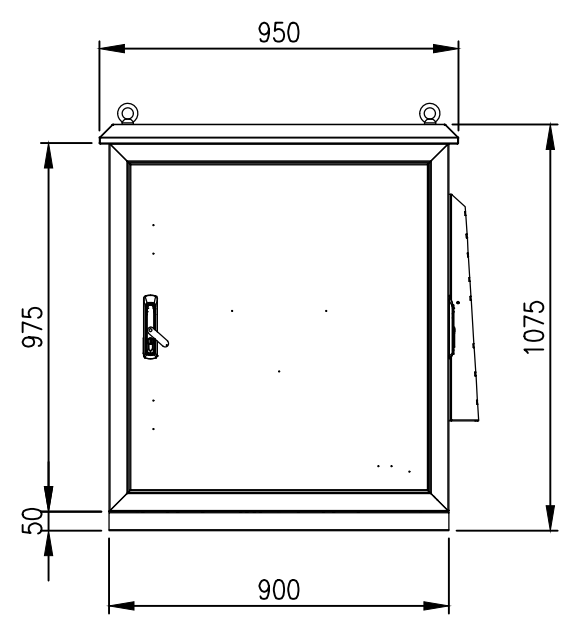

FRONT VIEW

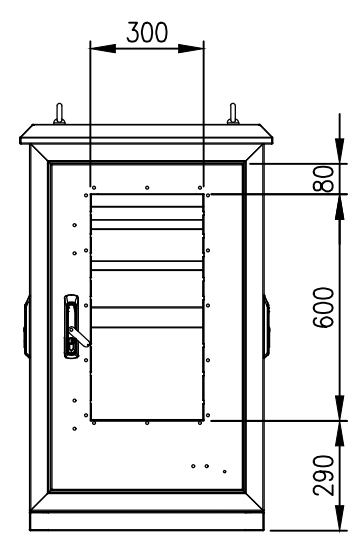

RIGHT SIDE VIEW

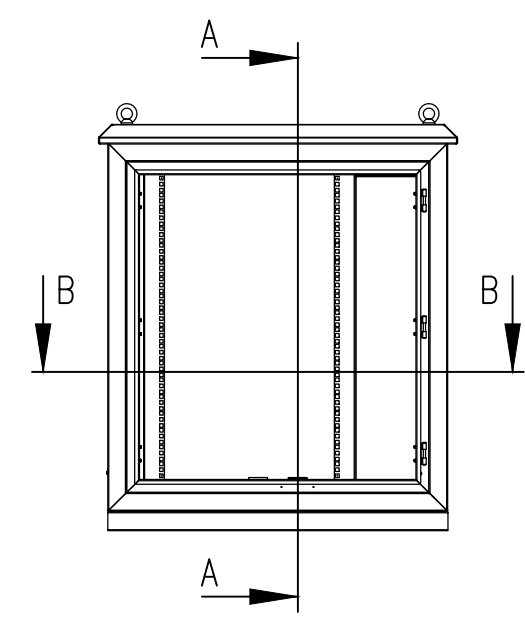

INTERIOR VIEW-DOOR REMOVED

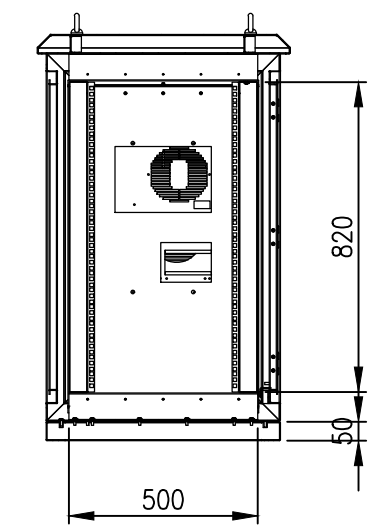

SECTION A-A

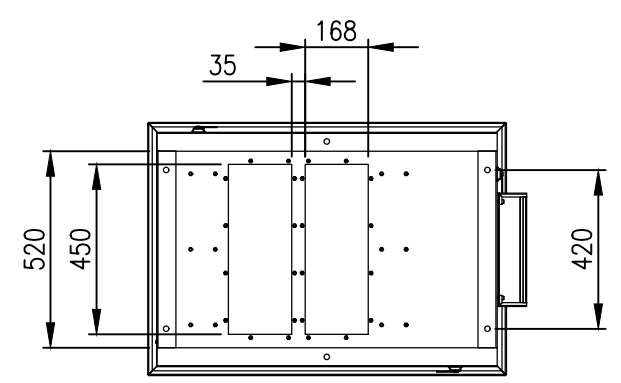

BOTTOM VIEW

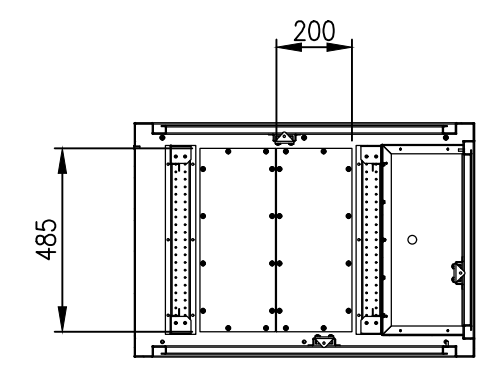

SECTION B-B

**MATERIAL**  
 BODY AND PLINTH: 2.5mm MARINE GRADE ALUMINIUM  
 DOORS: 2.5mm MARINE GRADE ALUMINIUM  
 19" DATA RAILS: 1.5mm GALVANISED STEEL SHEET  
 GLAND PLATE: 3.0mm ALUMINIUM  
 SEAL: POLYURETHANE  
 SURFACE TREATMENT: POWDER-COAT 80-120micron  
 COLOUR: RAL7035 LIGHT GREY, SMOOTH FINISH

PROTECTION: IP55  
 STANDARD: IEC62208, IEC/EN/AS60529, EIA-310D

© IP ENCLOSURES 2022.  
 THIS DRAWING SHALL NOT BE COPIED OR REPRODUCED  
 WITHOUT AUTHORISATION FROM IP ENCLOSURES.  
 www.ipenclosures.com.au

Itemref	Quantity	Title/Name, designation, material, dimension etc	Article No./Reference
Designed by IP	Checked by IP	Approved by - date 16/08/22	Filename IP-A1079062-AC035
		Date 16/08/22	Scale 1:20
			18U IP55 1075Hx900Wx620D ALUM. AC FIELD CABINET IP-A1079062-AC035
			Edition 0 Sheet 1/1