

RevNo	Revision note	Date	Signature	Checked
1	GENERAL REVISION	31/03/23	IP	IP

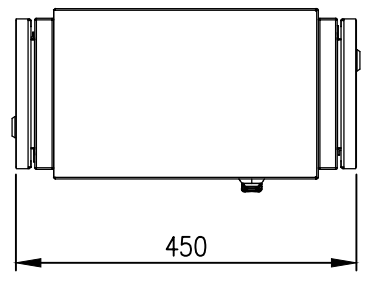

TOP VIEW

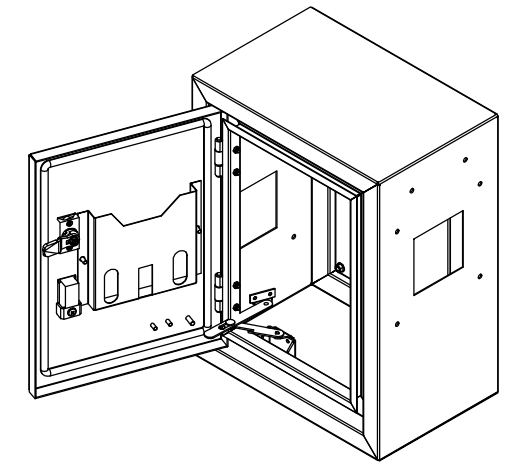
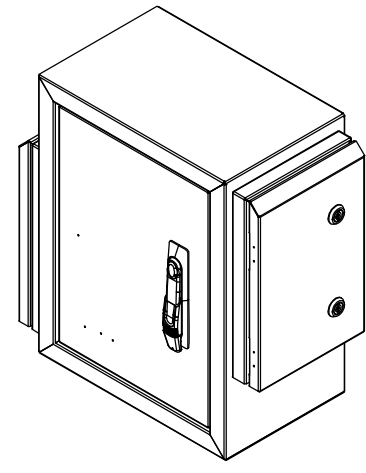
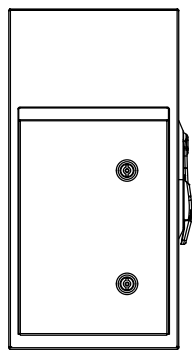

SIDE VIEW

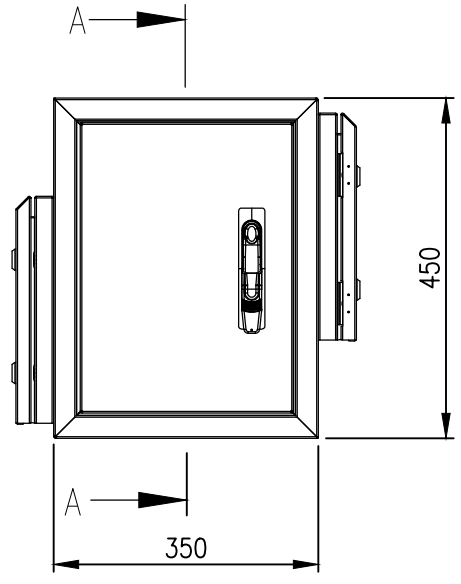

FRONT VIEW

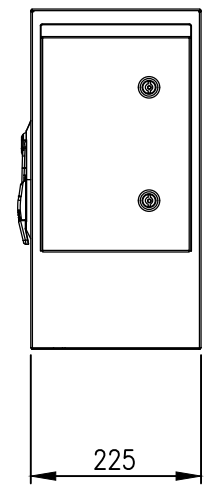

SIDE VIEW

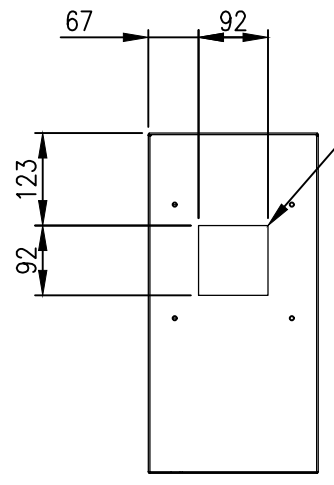

SECTION AA

FAN FILTER CUTOUT

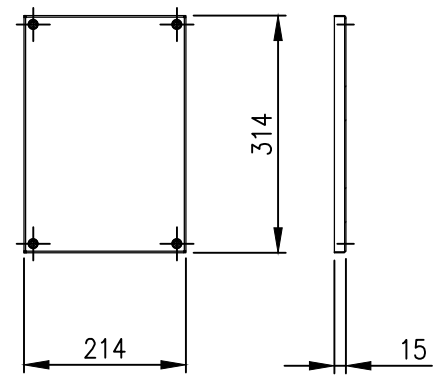

DEVICE MOUNTING PLATE

MATERIAL
 BODY: 1.5mm GALVANISED STEEL SHEET
 DOOR: 2.0mm GALVANISED STEEL SHEET
 SEAL: POLYURETHANE
 SURFACE TREATMENT: POWDER-COAT 80-120micron

PROTECTION: IP55 (VENTILATED)
STANDARD: IEC62208, IEC/EN/AS60529

© IP ENCLOSURES 2016.
 THIS DRAWING SHALL NOT BE COPIED OR REPRODUCED
 WITHOUT AUTHORISATION FROM IP ENCLOSURES.
 www.ipenclosures.com.au

Itemref	Quantity	Title/Name, designation, material, dimension etc	Article No./Reference
Designed by IP	Checked by IP	Approved by - date 13/10/20	Filename IP-453522
		Date 13/10/20	Scale 1:10
			450x350x225 FIELD CABINET (VENTILATED)
IP-453522			Edition 1
			Sheet 1/1