

RevNo	Revision note	Date	Signature	Checked
0	GENERAL REVISION		IP	IP

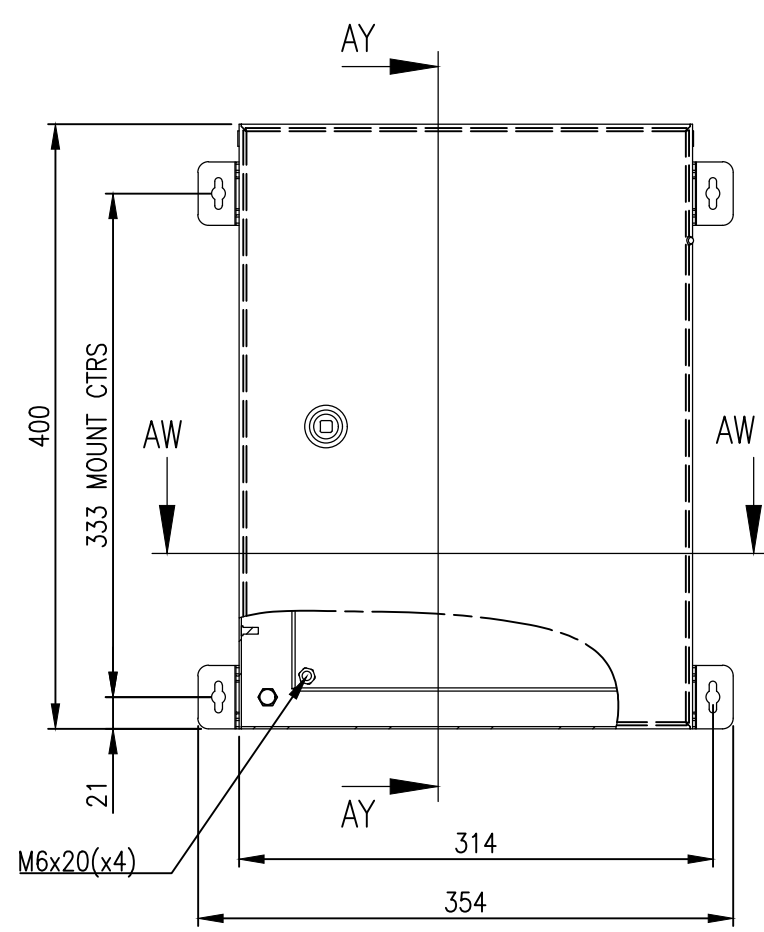

FRONT VIEW

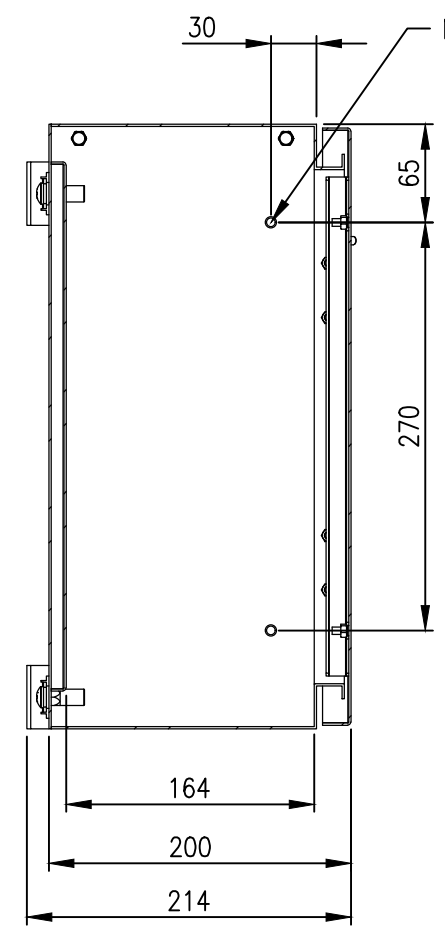

SECTION AV-AV

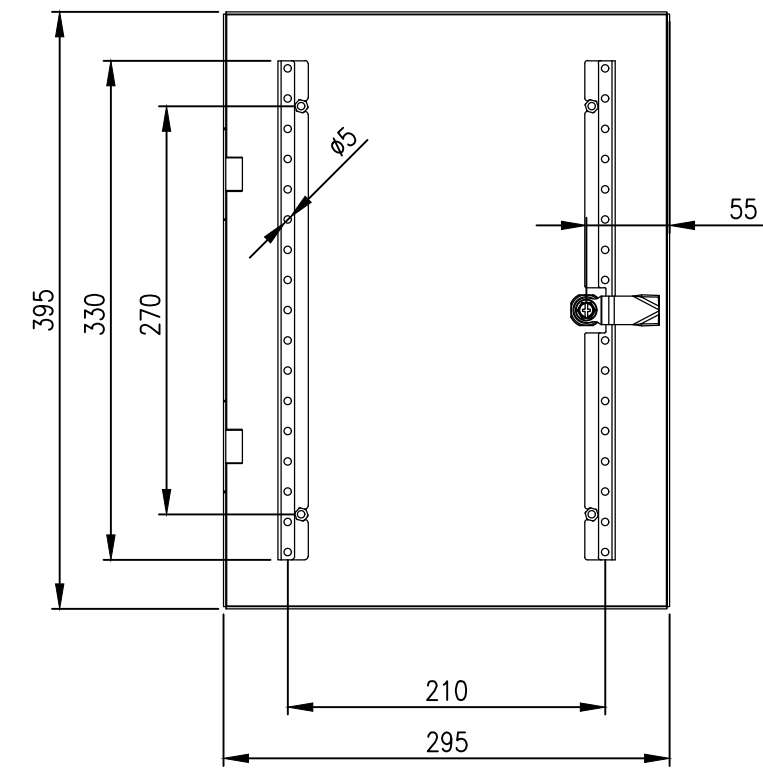

INSIDE DOOR VIEW

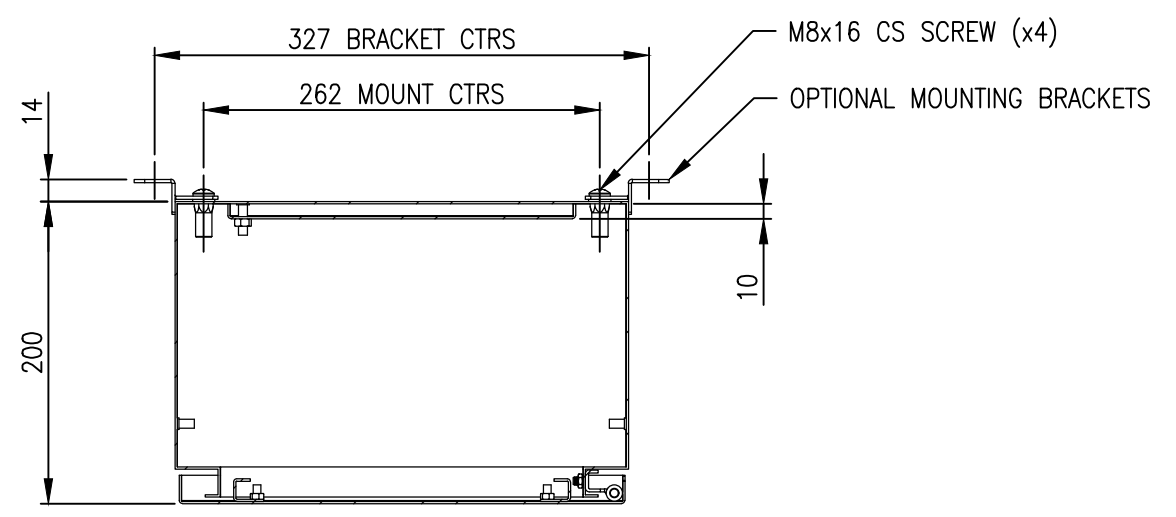
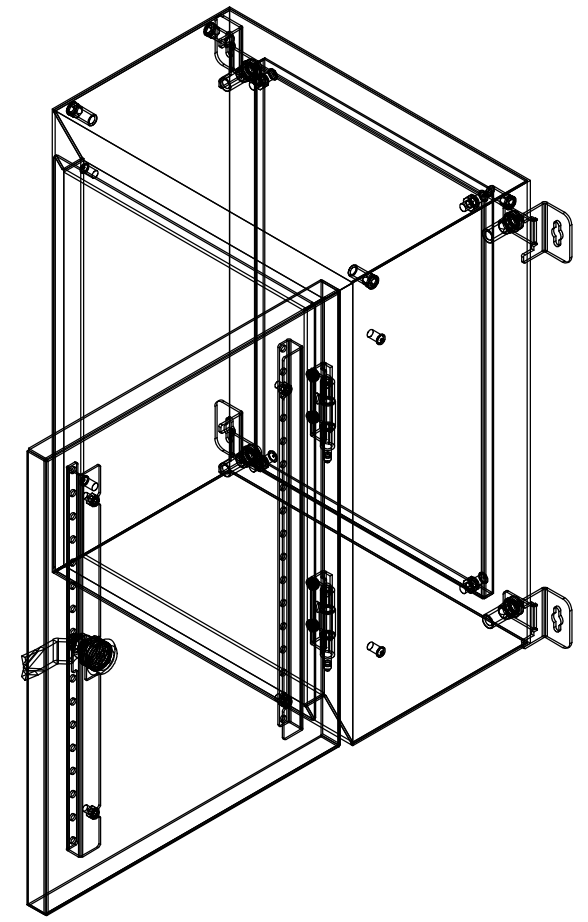

SECTION AW-AW

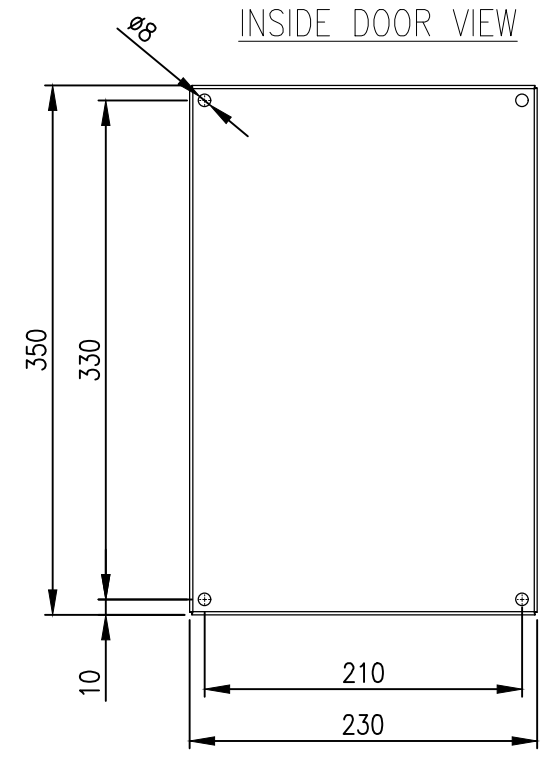

DEVICE MOUNTING PLATE

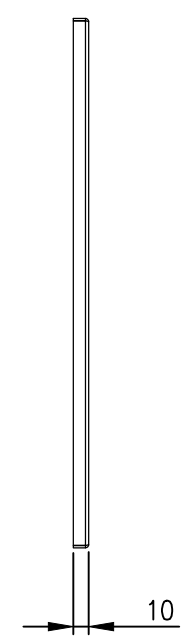

MATERIAL
 BODY: 1.5mm 304 STAINLESS STEEL
 DOOR: 1.5mm 304 STAINLESS STEEL
 DEVICE PLATE: 1.5mm GALV STEEL
 SEAL: POLYURETHANE

MASS: 8.8kg

PROTECTION: IP66 IK10, NEMA4x
STANDARD: IEC62208, IEC/EN/AS60529

© IP ENCLOSURES 2022.
 THIS DRAWING SHALL NOT BE COPIED OR REPRODUCED
 WITHOUT AUTHORISATION FROM IP ENCLOSURES.
 www.ipenclosures.com.au

Itemref	Quantity	Title/Name, designation, material, dimension etc	Article No./Reference
Designed by	Checked by	Approved by - date	Filename
IP	IP	28/09/22	IP-304-403020
Date	Scale	400x300x200 304SS ENCLOSURE	
28/09/22	1:1	IP-304-403020	Edition 0 Sheet 1/1