

RevNo	Revision note	Date	Signature	Checked
	GENERAL REVISION		IP	IP

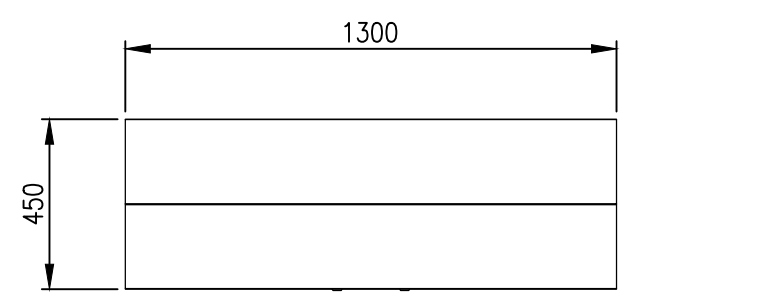

TOP VIEW

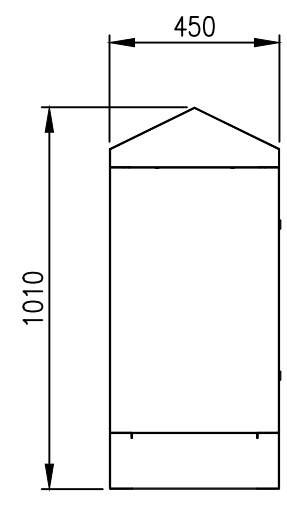
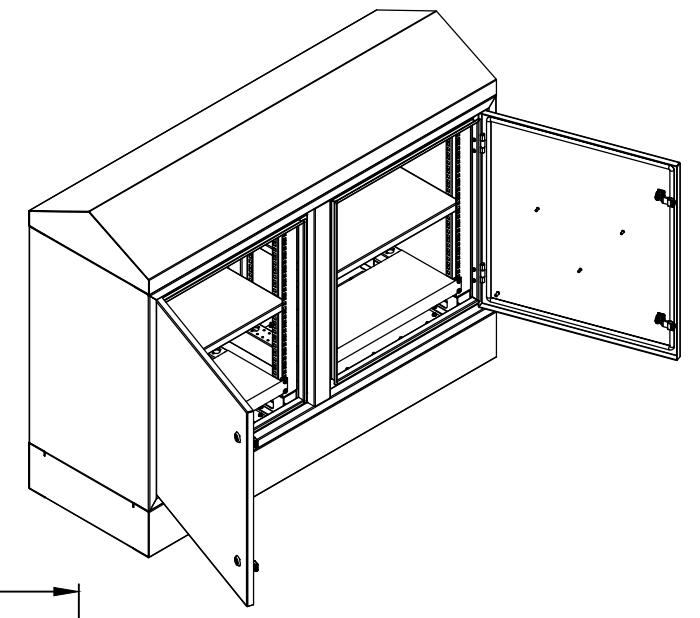

LEFT SIDE VIEW

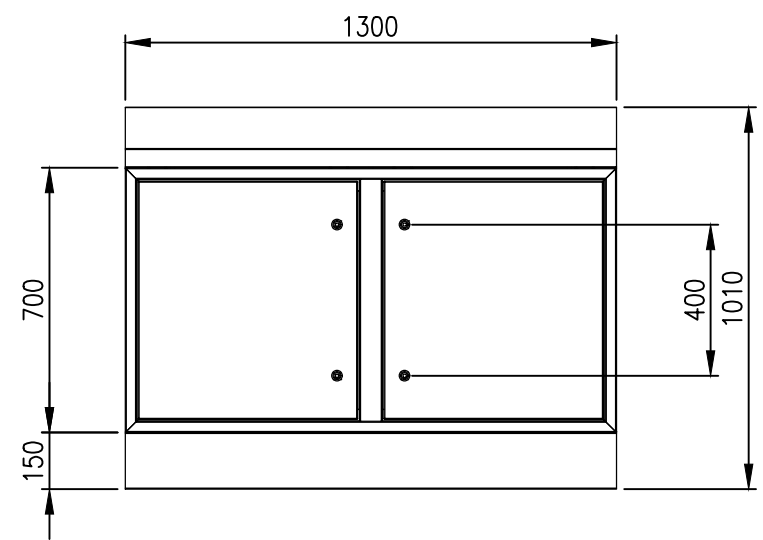

FRONT VIEW

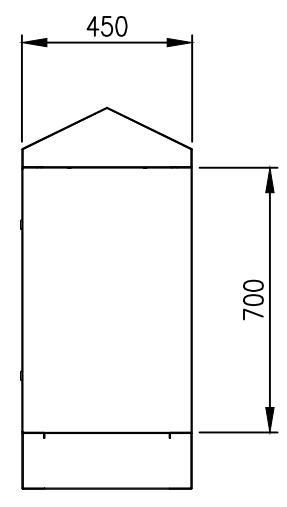

RIGHT SIDE VIEW

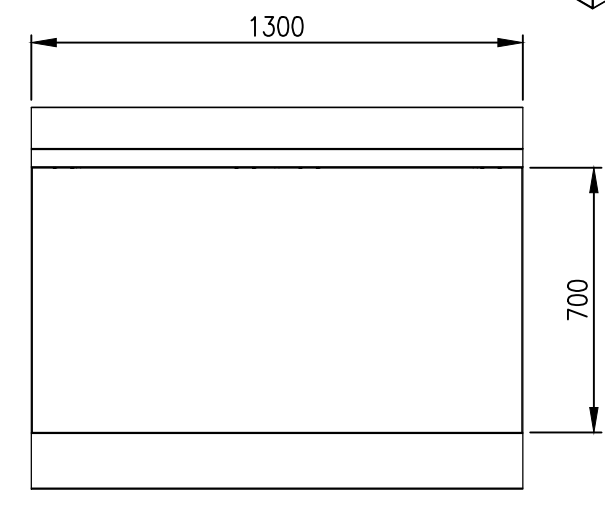

REAR VIEW

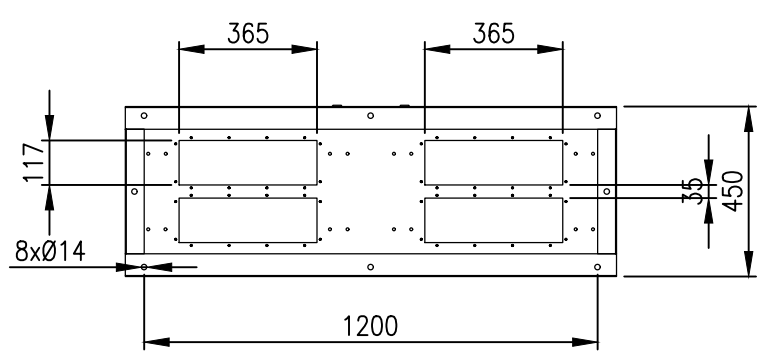

BOTTOM VIEW

MATERIAL
 BODY: 2.0mm GALVANISED STEEL SHEET
 DOOR: 2.0mm GALVANISED STEEL SHEET
 19" DATA RAILS: 1.5mm GALVANISED STEEL SHEET
 GLAND PLATE: 3.0mm ALUMINIUM
 SEAL: POLYURETHANE
 SURFACE TREATMENT: POWDER-COAT 80-120micron
 STANDARD COLOUR: RAL6005 MOSS GREEN

PROTECTION: IP66 IK10, NEMA 4 (NON-VENTILATED)
 STANDARD: IEC62208, IEC/EN/AS60529, EIA-310-D

© IP ENCLOSURES 2023.
 THIS DRAWING SHALL NOT BE COPIED OR REPRODUCED WITHOUT
 AUTHORISATION FROM IP ENCLOSURES.
 www.ipenclosures.com.au

Itemref	Quantity	Title/Name, designation, material, dimension etc	Article No./Reference
Designed by IP	Checked by IP	Approved by - date 19/06/23	Filename IP-2X12U6545-0-GRN
		Date 19/06/23	Scale 1:20
		2 x 12U (24U) 19" 1300W x 450D DOUBLE BAY (NV)	
		IP-2X12U6545-0-GRN	Edition 0
			Sheet 1/1

